

MAPLUS

CATALOG²⁰²⁰₂₀₂₁

**#READY
FOR
RACING!**

MAPLUS FLUORINE EXPERTS

From the passion for skiing and the mastery of the fluorine chemistry Maplus, a division specialized in ski wax and technical accessories for ski preparation, was born in 1997.

Thanks to the synergies with the industrial chemical research of Maflon SPA, a dynamic and innovative company specialized in the production of high-tech fluorinated products, owned by Mazza Holding of Castelli Calepio (Bg), this industrial company, 100% Italian, in just twenty years, braving more long-lived competitors out, has managed to reach a leading position in high-level competitions.

Since its debut in the cross-country World Championship in Ramsau in 1998, with the novelty of a perfluorinated liquid product, up to the successes of the Pyeongchang Olympics in 2017 and Åre 2019, Maplus has become, with its perfluorinated products, the reference in terms of gliding and durability in the ski and snowboard World Cups.

We can declare with satisfaction that today Maplus waxes are used in competition by all the National Teams and by all the ski companies present in the World Cup!

And yet Maplus does not care only of athletes and their results: the experience gained at the highest level has allowed us to develop a complete line of wax ideal to meet the needs of any skier and snowboarder, from the freeride addicted to the beginner who wants an easy to manage equipment, up to the needs of the professional laboratories for the rentals.

MAPLUS

GENERAL CATALOG 2020/21

NEW ECO- FLUORWAX*

Respect for norms and the health of human beings and environmental have always been, and will continue to be, our priorities. In order to get our results in research and development of fluorinated products, we respect the most advanced rules in term of sustainable development. We have nevertheless invested the maximum of our energy and our efforts in finding new solutions and new products.

Now we are able to guarantee, in light of the new regulations, the utmost respect for anti-pollution and environmental protection standards together with the high standards skiwaxes to which our customers have been accustomed to for years.



*In compliance with Regulation (EU) 2017-1000.

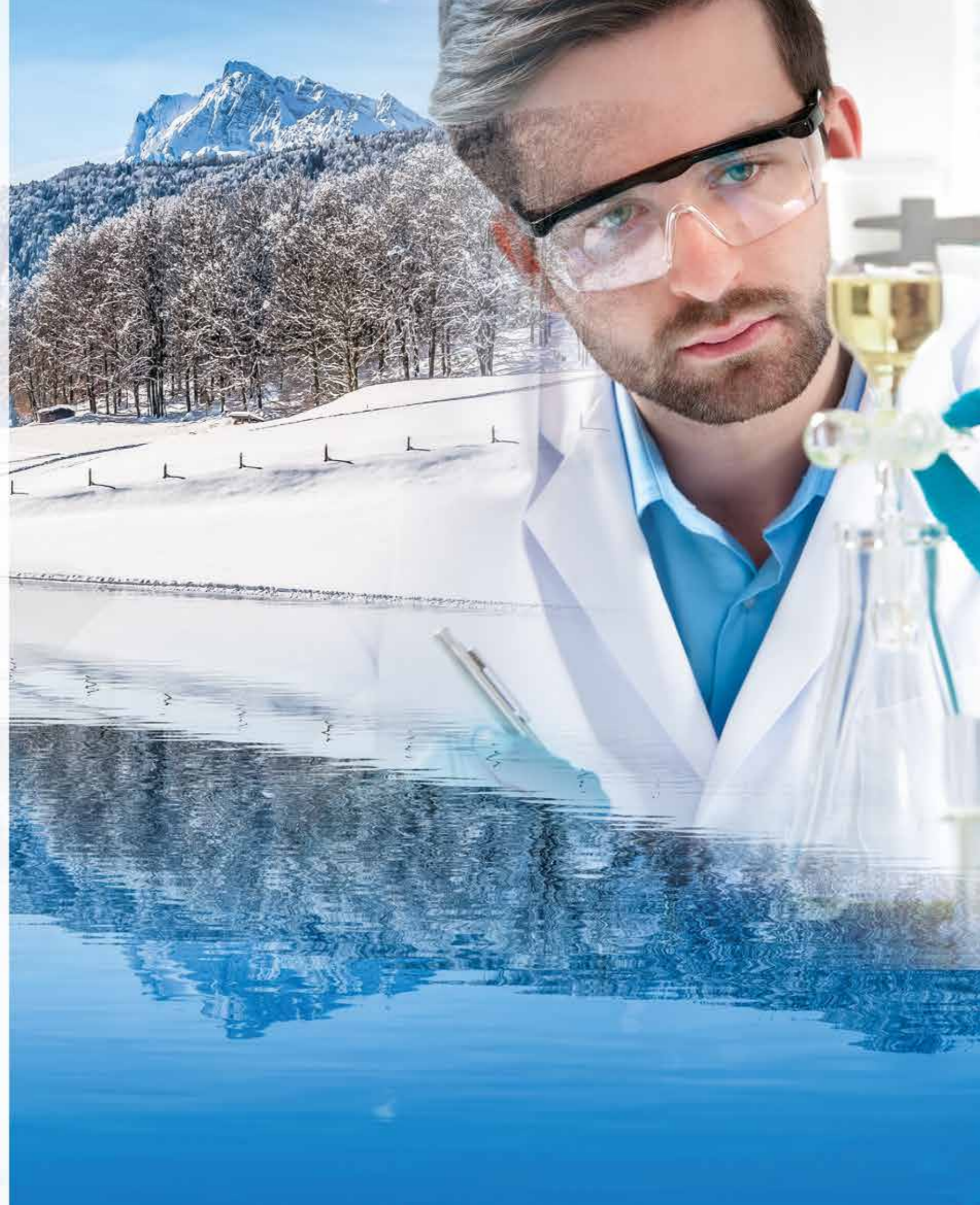



SKI WAX

ALPINE/NORDIC/SNOWBOARD
RACE
LINE



XLS
EXTRA LONG LASTING SPEED

Liquid accelerator for competition. Use with any type of artificial snow and natural snow from new moist to old transformed, icy and wet with temperatures from 0 ° to -6 °C and relative air humidity over 50%.

PRODUCTS

XLS 4.0
CODE: MW0894N
SIZE : 50 ml

USE

SNOW TEMP: 0° / -6° C
HUMIDITY: 50 / 100%



XLS
EXTRA LONG LASTING SPEED

Liquid accelerator for competition. Use with any type of artificial snow and natural snow from powder to transformed compact and icy with temperatures from -6° to -12°C and relative air humidity over 50%.

PRODUCTS

XLS 6.0
CODE: MW0896N
SIZE : 50 ml

USE

SNOW TEMP: -6° / -12° C
HUMIDITY: 50 / 100%



FP4
PERFLUORINATED POWDER WAX

Fluorocarbon powder wax for racing. Use for all type of snow with temperature from -22°C to -8°C. Air humidity from 30% to 70%. Recommended hot application with waxing iron at 160°C.

PRODUCTS

FP4 COLD
CODE: MW0840N
SIZE : 30 gr

USE

SNOW TEMP: -22° / -8° C
HUMIDITY: 30 / 70%
APPLICATION: 160 °C ☹



FP4
PERFLUORINATED POWDER WAX

Fluorocarbon powder wax for racing. Use for all type of snow with temperature from -16°C to -2°C. Air humidity from 40% to 80%. Good also on icy hard snow in springtime condition. Recommended hot application with waxing iron at 160°C.

PRODUCTS

FP4 SUPERMED
CODE: MW0843N
SIZE : 30 gr

USE

SNOW TEMP: -16° / -2° C
HUMIDITY: 40 / 80%
APPLICATION: 160 °C ☹



FP4
PERFLUORINATED POWDER WAX

Fluorocarbon powder wax for racing. Use for all type of snow with temperature from -9°C to -2°C. Air humidity from 60% to 100%. Recommended hot application with waxing iron at 160°C.

PRODUCTS

FP4 MED
CODE: MW0841N
SIZE : 30 gr

USE

SNOW TEMP: -9° / -2° C
HUMIDITY: 60 / 100%
APPLICATION: 160 °C ☹



FP4
PERFLUORINATED POWDER WAX

Fluorocarbon powder wax for racing. Use for all type of snow with temperature from -3°C to 0°C. Air humidity from 60% to 100%. Recommended hot application with waxing iron at 160°C.

PRODUCTS

FP4 HOT
CODE: MW0842N
SIZE : 30 gr

USE

SNOW TEMP: -3° / 0° C
HUMIDITY: 60 / 100%
APPLICATION: 160 °C ☹



FP4
PERFLUORINATED LIQUID WAX

Fluorocarbon liquid wax for racing. Use for all type of snow with temperature from -22°C to -8°C. Air humidity from 30% to 70%. Excellent as accelerant and corrector at the start on fluorocarbon powder wax or on fluorinated paraffin. Recommended cold application with merino wool rollers.

PRODUCTS

FP4 COLD
CODE: MW0850N
SIZE : 50 ml

USE

SNOW TEMP: -22° / -8° C
HUMIDITY: 30 / 70%



FP4
PERFLUORINATED LIQUID WAX

Fluorocarbon liquid wax for racing. Use for all type of snow with temperature from -16°C to -2°C. Air humidity from 40% to 80%. Good also on icy hard snow in springtime condition. Excellent as accelerant and corrector at the start on fluorocarbon powder wax or on fluorinated paraffin. Recommended cold application with merino wool rollers.

PRODUCTS

FP4 SUPERMED
CODE: MW0853N
SIZE : 50 ml

USE

SNOW TEMP: -16° / -2° C
HUMIDITY: 40 / 80%



FP4
PERFLUORINATED LIQUID WAX

Fluorocarbon liquid wax for racing. Use for all type of snow with temperature from -9°C to -2°C. Air humidity from 60% to 100%. Excellent as accelerant and corrector at the start on fluorocarbon powder wax or on fluorinated paraffin. Recommended cold application with merino wool rollers.

PRODUCTS

FP4 MED
CODE: MW0851N
SIZE : 50 ml

USE

SNOW TEMP: -9° / -2° C
HUMIDITY: 60 / 100%



FP4
PERFLUORINATED LIQUID WAX

Fluorocarbon liquid wax for racing. Use for all type of snow with temperature from -3°C to 0°C. Air humidity from 60% to 100%. Excellent as accelerant and corrector at the start on fluorocarbon powder wax or on fluorinated paraffin. Recommended cold application with merino wool rollers.

PRODUCTS

FP4 HOT
CODE: MW0852N
SIZE : 50 ml

USE

SNOW TEMP: -3° / 0° C
HUMIDITY: 60 / 100%



FP4
PERFLUORINATED SOLID WAX

Fluorocarbon solid wax for racing. Use for all type of snow with temperature from -22°C to -8°C. Air humidity from 30% to 70%. Excellent as accelerant and corrector at the start on fluorocarbon powder wax or on fluorinated paraffin. Recommended cold application with polyester and merino wool rollers.

PRODUCTS

FP4 COLD
CODE: MW0860N
SIZE: 20 gr

USE SNOW TEMP: -22° / -8° C
HUMIDITY: 30 / 70%



FP4
PERFLUORINATED SOLID WAX

Fluorocarbon solid wax for racing. Use for all type of snow with temperature from -16°C to -2°C. Air humidity from 40% to 80%. Good also on icy hard snow in springtime condition. Excellent as accelerant and corrector at the start on fluorocarbon powder wax or on fluorinated paraffin. Recommended cold application with polyester and merino wool rollers.

PRODUCTS

FP4 SUPERMED
CODE: MW0863N
SIZE: 20 gr

USE SNOW TEMP: -16° / -2° C
HUMIDITY: 40 / 80%



FP4
PERFLUORINATED SOLID WAX

Fluorocarbon solid wax for racing. Use for all type of snow with temperature from -9°C to -2°C. Air humidity from 60% to 100%. Excellent as accelerant and corrector at the start on fluorocarbon powder wax or on fluorinated paraffin. Recommended cold application with polyester and merino wool rollers.

PRODUCTS

FP4 MED
CODE: MW0861N
SIZE: 20 gr

USE SNOW TEMP: -9° / -2° C
HUMIDITY: 60 / 100%



FP4
PERFLUORINATED SOLID WAX

Fluorocarbon solid wax for racing. Use for all type of snow with temperature from -3°C to 0°C. Air humidity from 60% to 100%. Excellent as accelerant and corrector at the start on fluorocarbon powder wax or on fluorinated paraffin. Recommended cold application with polyester and merino wool rollers.

PRODUCTS

FP4 HOT
CODE: MW0862N
SIZE: 20 gr

USE SNOW TEMP: -3° / 0° C
HUMIDITY: 60 / 100%

FLASH
FLUORINATED
LIQUID POLYMER
HIGH SPEED ACCELERATOR

Fluorinated liquid polymer for racing. Use for wet, water-ice and icy snow from -3° to 0°C with completely transformed snow crystal with medium and big grain. It works great from hard coarse snow to wet snow and in all intermediate conditions while step by step the sun melts the snow. The Yellow Flash is also the best in raining conditions but only if it's raining over completely transformed snow as above mentioned. If it's snowing with new big moist and wet flakes together with raining on new moist and polish snow, Yellow Flash does not work. It needs at least one day of snow transformation then it works greatly. Air humidity from 60% to 100%. Excellent as accelerant and corrector at the start on fluorocarbon powder waxes or on fluorinated paraffins. Recommended cold application with the felt cap-applicator.

PRODUCTS

YELLOW FLASH
CODE: MW0662N
SIZE: 50 ml

USE SNOW TEMP: -3° / 0° C
HUMIDITY: 60 / 100%



HP3
HIGH FLUORINATED PARAFFIN

High fluoro powder paraffin for racing use as final product or as a base before applying fluorocarbon waxes FP4. Use for snow from -30°C to -10°C. Air humidity from 50% to 90%. This paraffin can be used alone as above mentioned or as a hardener for the high fluorinated paraffins HP3 VIOLET and HP3 RED in case of abrasive new or conserved snow or mixed with artificial snow. Use hot application with the waxing iron at 160°C.

PRODUCTS

HP3 GREEN POWDER
CODE: MW0900N
SIZE: 50 gr

USE SNOW TEMP: -30° / -10° C
HUMIDITY: 50 / 90%
APPLICATION: 160 °C E



HP3
HIGH FLUORINATED PARAFFIN

**HP3 BLUE MOLY
COLD ADDITIVE**

CODE: MW0901MN - 50 g
CODE: MW0911MN - 250 gr
CODE: MW0921MN - 1 kg

USE SNOW TEMP: -25° / -10° C
HUMIDITY: 50 / 90%
APPLICATION: 150° / 160 °C E

High fluoro solid paraffin with moly for racing use as final product or as a base before applying fluorocarbon waxes FP4. Use for old abrasive dry snow with temperature from -25°C to -10°C. Air humidity from 50% to 90%. Excellent during a long period without snow falling and with dirty snow. This paraffin can be also used as a moly hardener for HP3 VIOLET and HP3 RED in case of old, abrasive, windy and dirty snow, both natural and artificial. Use hot application with the waxing iron at 150°/160°C.



HP3
HIGH FLUORINATED PARAFFIN

HP3 VIOLET

CODE: MW0902N - 50 gr
CODE: MW0912N - 250 gr
CODE: MW0922N - 1 kg

USE SNOW TEMP: -12° / -6° C
HUMIDITY: 60 / 100%
APPLICATION: 140° / 150 °C E

High fluoro solid paraffin for racing use as final product or as a base before applying fluorocarbon waxes FP4. Use for all type of snow with temperature from -12°C to -6°C. Air humidity from 60% to 100%. In case of new or conserved abrasive snow and artificial snow, mix HP3 VIOLET with HP3 GREEN or LP2 GREEN if the humidity is lower. Use hot application with the waxing iron at 140°/150°C.



HP3
HIGH FLUORINATED PARAFFIN

HP3 RED

CODE: MW0903N - 50 gr
CODE: MW0913N - 250 gr
CODE: MW0923N - 1 kg

USE SNOW TEMP: -7° / -3° C
HUMIDITY: 60 / 100%
APPLICATION: 130° / 140 °C E

High fluoro solid paraffin for racing use as final product or as a base before applying fluorocarbon waxes FP4. Use for all type of snow with temperature from -7°C to -3°C. Air humidity from 60% to 100%. In case of new or conserved abrasive snow, artificial snow and springtime icy snow, mix HP3 RED with HP3 GREEN or LP2 GREEN if the humidity is lower. Use hot application with the waxing iron at 130°/140°C.



HP3
HIGH FLUORINATED PARAFFIN

HP3 YELLOW 1

CODE: MW0904N - 50 gr
CODE: MW0914N - 250 gr
CODE: MW0924N - 1 kg

PRODUCTS

USE

SNOW TEMP: -4° / 0° C
HUMIDITY: 60 / 100%
APPLICATION: 110° / 120 °C ☺

High fluoro solid paraffin for racing use as final product or as a base before applying fluorocarbon waxes FP4. Use for new moist not wet snow with temperature from -4°C to 0°C. Air humidity from 60% to 100%. Is the only choice with polish and sticky snow. Use hot application with the waxing iron at 110°/120°C.



HP3
HIGH FLUORINATED PARAFFIN

HP3 YELLOW 2

CODE: MW0905N - 50 gr
CODE: MW0915N - 250 gr
CODE: MW0925N - 1 kg

PRODUCTS

USE

SNOW TEMP: -5° / -1° C
HUMIDITY: 60 / 100%
APPLICATION: 120° / 130 °C ☺

High fluoro solid paraffin for racing use as final product or as a base before applying fluorocarbon waxes FP4. Use for transformed snow, not wet and springtime icy, with temperature from -5°C to -1°C. Air humidity from 60% to 100%. Use hot application with the waxing iron at 120°/130°C.



HP3
HIGH FLUORINATED PARAFFIN

HP3 ORANGE 1

CODE: MW0906N - 50 gr
CODE: MW0916N - 250 gr
CODE: MW0926N - 1 kg

PRODUCTS

USE

SNOW TEMP: -4° / 0° C
HUMIDITY: 60 / 100%
APPLICATION: 120° / 130 °C ☺

High fluoro solid paraffin for racing use as final product or as a base before applying fluorocarbon waxes FP4. Use for springtime icy and grainy snow, but little wet, with temperature from -4°C to 0°C. Air humidity from 60% to 100%. Use hot application with the waxing iron at 120°/130°C.



HP3
HIGH FLUORINATED PARAFFIN

HP3 ORANGE 2

CODE: MW0907N - 50 gr
CODE: MW0917N - 250 gr
CODE: MW0927N - 1 kg

PRODUCTS

USE

SNOW TEMP: -3° / 0° C
HUMIDITY: 60 / 100%
APPLICATION: 100° / 110 °C ☺

High fluoro solid paraffin for racing use as final product or as a base before applying fluorocarbon waxes FP4. Use for clean wet snow, with temperature from -3°C to 0°C. and rainy conditions. Air humidity from 60% to 100%. Use hot application with the waxing iron at 100°/110°C.



HP3
HIGH FLUORINATED PARAFFIN

**HP3 ORANGE 2 MOLY
HOT ADDITIVE**

CODE: MW0907MN - 50 gr
CODE: MW0917MN - 250 gr
CODE: MW0927MN - 1 kg

PRODUCTS

USE

SNOW TEMP: -3° / 0° C
HUMIDITY: 60 / 100%
APPLICATION: 100° / 110 °C ☺

High fluoro solid paraffin with moly for racing use as final product or as a base before applying fluorocarbon waxes FP4. Use for wet snow and dirty snow from -3°C to 0°C. and rainy conditions. Air humidity from 60% to 100%. This paraffin can be used as a moly additive for HP3 RED, YELLOW 2, and ORANGE 1 in case of old dirty snow, both natural and artificial. Use hot application with the waxing iron at 100°/110°C.



LP2
MEDIUM FLUORINATED PARAFFIN

PRODUCTS

LP2 GREEN POWDER

CODE: MW0950N
SIZE: 100 gr

USE

SNOW TEMP: -30° / -10° C
HUMIDITY: 20 / 60%
APPLICATION: 160 °C ☺

Fluorinated powder paraffin for racing use as final product or as a base before applying fluorocarbon waxes FP4. Use for fine-abrasive snow from -30°C to -10°C. Air humidity from 20% to 60%. This paraffin can be also used as an hardener for paraffins LP2 VIOLET and LP2 RED and HP3 VIOLET and HP3 RED in case of new or conserved abrasive snow and mixed with artificial snow. Use hot application with the waxing iron at 160°C.



PRODUCTS

LP2
MEDIUM FLUORINATED PARAFFIN

LP2 BLUE

CODE: MW0951N - 100 gr
CODE: MW0961N - 250 gr
CODE: MW0971N - 1 kg

USE

SNOW TEMP: -25° / -10° C
HUMIDITY: 20 / 60%
APPLICATION: 150° / 160 °C ☺

Fluorinated solid paraffin for racing use as final product or as a base before applying fluorocarbon waxes FP4. Use for old transformed snow, with temperature from -25°C to -10°C. Air humidity from 20% to 60%. Excellent during a long period without snow falling. Use hot application with the waxing iron at 150°/160°C.



PRODUCTS

LP2
MEDIUM FLUORINATED PARAFFIN

LP2 VIOLET

CODE: MW0952N - 100 gr
CODE: MW0962N - 250 gr
CODE: MW0972N - 1 kg

USE

SNOW TEMP: -12° / -6° C
HUMIDITY: 20 / 60%
APPLICATION: 140° / 150 °C ☺

Fluorinated solid paraffin for racing use as final product or as a base before applying fluorocarbon waxes FP4. Use for all type of snow with temperature from -12°C to -6°C. Air humidity from 20% to 60%. In case of new or conserved abrasive snow and artificial snow, mix LP2 VIOLET with LP2 GREEN. Use hot application with the waxing iron at 140°/150°C.



PRODUCTS

LP2
MEDIUM FLUORINATED PARAFFIN

LP2 RED

CODE: MW0953N - 100 gr
CODE: MW0963N - 250 gr
CODE: MW0973N - 1 kg

USE

SNOW TEMP: -7° / -3° C
HUMIDITY: 30 / 60%
APPLICATION: 130° / 140 °C ☺

Fluorinated solid paraffin for racing use as final product or as a base before applying fluorocarbon waxes FP4. Use for all type of snow with temperature from -7°C to -3°C. Air humidity from 30% to 60%. In case of new or conserved abrasive snow, artificial snow and springtime icy snow, mix LP2 RED with LP2 GREEN. Use hot application with the waxing iron at 130°/140°C.



PRODUCTS
LP2
 MEDIUM FLUORINATED PARAFFIN
LP2 YELLOW
 CODE: MW0954N - 100 gr
 CODE: MW0964N - 250 gr
 CODE: MW0974N - 1 kg

USE
 SNOW TEMP: -5° / -1° C
 HUMIDITY: 30 / 60%
 APPLICATION: 110° / 120 °C ☺

Fluorinated solid paraffin for racing use as final product or as a base before applying fluorocarbon waxes FP4. Use for all type of snow, not wet, with temperature from -5°C to -1°C. Air humidity from 30% to 60%. Use hot application with the waxing iron at 110°/120°C.



PRODUCTS
LP2
 MEDIUM FLUORINATED PARAFFIN
LP2 ORANGE
 CODE: MW0955N - 100 gr
 CODE: MW0965N - 250 gr
 CODE: MW0975N - 1 kg

USE
 SNOW TEMP: -4° / 0° C
 HUMIDITY: 30 / 60%
 APPLICATION: 100° / 110 °C ☺

Fluorinated solid paraffin for racing use as final product or as a base before applying fluorocarbon waxes FP4. Use for all type of wet snow with temperature from -4°C to 0°C and rainy conditions. Air humidity from 30% to 60%. Use hot application with the waxing iron at 100°/110°C.

CLEANER LINE



PRODUCTS
CLEANER
FLUORCLEAN
 CODE: MW0750N - 150 ml - SPRAY
 CODE: MW0751N - 0,5 lt - LIQUID
 CODE: MW0752N - 1 lt - LIQUID

Liquid cleaner to remove residuals of any type of perfluorinated wax and the dirt collected during activity.



PRODUCTS
CLEANER
CLEAN
 CODE: MW0755 - 150 ml - SPRAY
 CODE: MW0756 - 0,5 lt - LIQUID
 CODE: MW0757 - 1 lt - LIQUID
 CODE: MW0758 - 4,9 lt - LIQUID

Liquid cleaner to remove residuals of any type of paraffin (fluorinated paraffin included) and the dirt collected during activity.



PRODUCTS
RACING
 BASE PARAFFIN
ARCTIC BASE
 CODE: MW1000 - POWDER - 100 gr
 CODE: MW0810 - 250 gr
 CODE: MW0820 - 1 kg

USE
 SNOW TEMP: -30° / -10° C
 APPLICATION: 160 °C ☺

Powder and solid paraffin for training use and racing. Use for new, fine, abrasive snow with temperature from -30°C to -10°C. In case of very abrasive old icy snow (spring snow and glacier snow), this paraffin can be used over the fluorocarbon waxes FP4 to increase their long lasting. The final result will be a lower hydrophobia. It can also be used as universal hardener to protect the polyethylene base along the steel edges foils in case of natural or artificial very abrasive snow. Use hot application with the waxing iron at 160°C.



PRODUCTS
RACING
 BASE PARAFFIN
MED BASE
 CODE: MW0870 - 250 gr
 CODE: MW0875 - 1 kg

USE
 SNOW TEMP: -10° / -5° C
 APPLICATION: 130° / 140 °C ☺

Solid base paraffin for any type of snow with temperature from -10°C to -5°C. It's an excellent product for the protection of racing ski bases and it can be used as universal training and testing base. Use hot application with the waxing iron at 130°/140°C.



PRODUCTS
RACING
 BASE PARAFFIN
SOFT BASE
 CODE: MW0871 - 250 gr
 CODE: MW0876 - 1 kg

USE
 SNOW TEMP: -5° / 0° C
 APPLICATION: 120° / 130 °C ☺

Solid base paraffin for any type of snow with temperature from -5°C to 0°C. It's an excellent product for the saturation and the protection of racing ski bases and it can be used as universal training and testing base. It has a melting point of 60°C so it's the best product for the hot saturation of polyethylene ski bases with the thermo-box or the thermo-cover. Use hot application with the waxing iron at 120°/130°C.



PRODUCTS
RACING
 BASE PARAFFIN
XSOFT BASE
 CODE: MW0873 - 250 gr
 CODE: MW0878 - 1 kg

USE
 SNOW TEMP: -2° / 0° C
 APPLICATION: 110° / 120 °C ☺

Solid base paraffin for any type of snow with temperature from -2°C to 0°C. It's an excellent product for the saturation and the protection of racing ski bases. It has a melting point of 48°C so it's a very good product for the hot saturation of polyethylene ski bases with the thermo-box or the thermo-cover. Use hot application with the waxing iron at 110°/120°C.



ALPINE/NORDIC/SNOWBOARD

SKI WAX | **SPORT**
LINE



PRODUCTS

LP15
LOW FLUORINATED PARAFFIN

LP15 VIOLET

CODE: MW0400N - 100 gr
CODE: MW0410N - 250 gr
CODE: MW0420N - 1 kg

USE

AIR TEMP: -19° / -9° C
HUMIDITY: > 50 %
APPLICATION: 140° / 150 °C ☺

Low fluoro solid paraffin for training use and leisure. Use for all type of snow, with temperature from -19°C to -9°C. Performing use with air humidity > 50%. Use hot application with the waxing iron at 140°/150°C.



PRODUCTS

BP10
HYDRO CARBON PARAFFIN

BP10 VIOLET

CODE: MW0300 - 100 gr
CODE: MW0310 - 250 gr
CODE: MW0320 - 1 kg

USE

AIR TEMP: -19° / -9° C
HUMIDITY: < 50 %
APPLICATION: 140° / 150 °C ☺

Solid paraffin for training use and leisure. Use for all type of snow, not wet, with temperature from -19°C to -9°C. Performing use with air humidity < 50%. Use hot application with the waxing iron at 140°/150°C.



PRODUCTS

LP15
LOW FLUORINATED PARAFFIN

LP15 RED

CODE: MW0401N - 100 gr
CODE: MW0411N - 250 gr
CODE: MW0421N - 1 kg

USE

AIR TEMP: -9° / -3° C
HUMIDITY: > 50 %
APPLICATION: 130° / 140 °C ☺

Low fluoro solid paraffin for training use and leisure. Use for all type of snow, not wet, with temperature from -9°C to -3°C. It's an excellent product for the protection of ski bases and it can be used as universal racing and training base. Performing use with air humidity > 50%. Use hot application with the waxing iron at 130°/140°C.



PRODUCTS

BP10
HYDRO CARBON PARAFFIN

BP10 RED

CODE: MW0301 - 100 gr
CODE: MW0311 - 250 gr
CODE: MW0321 - 1 kg

USE

AIR TEMP: -9° / -3° C
HUMIDITY: < 50 %
APPLICATION: 130° / 140 °C ☺

Solid paraffin for training use and leisure. Use for all type of snow, not wet, with temperature from -9°C to -3°C. It's an excellent product for the protection of ski bases and it can be used as universal racing and training base. Performing use with air humidity < 50%. Use hot application with the waxing iron at 130°/140°C.



PRODUCTS

LP15
LOW FLUORINATED PARAFFIN

LP15 YELLOW

CODE: MW0402N - 100 gr
CODE: MW0412N - 250 gr
CODE: MW0422N - 1 kg

USE

AIR TEMP: -3° / +9° C
HUMIDITY: > 50 %
APPLICATION: 120° / 130 °C ☺

Low fluoro solid paraffin for training use and leisure. Use for all type of snow, not wet, with temperature from -3°C to +9°C. Performing use with air humidity > 50%. Use hot application with the waxing iron at 120°/130°C.



PRODUCTS

BP10
HYDRO CARBON PARAFFIN

BP10 YELLOW

CODE: MW0302 - 100 gr
CODE: MW0312 - 250 gr
CODE: MW0322 - 1 kg

USE

AIR TEMP: -3° / +9° C
HUMIDITY: < 50 %
APPLICATION: 120° / 130 °C ☺

Solid paraffin for training use and leisure. Use for all type of snow, not wet, with temperature from -3°C to +9°C. Performing use with air humidity < 50%. Use hot application with the waxing iron at 120°/130°C.



ALPINE/NORDIC/SNOWBOARD

SKI WAX

PER
FOR
MAN
CE LINE

LIQUID SKIWAX
HIGH FLUORINATED PARAFFIN

PRODUCTS

HP3 COLD

CODE: MW0930N - 75 ml
CODE: MW0940N - 0,5 lt

HP3 MED

CODE: MW0931N - 75 ml
CODE: MW0941N - 0,5 lt

HP3 HOT

CODE: MW0932N - 75 ml
CODE: MW0942N - 0,5 lt

USE

SNOW TEMP: -22°/-8° C
HUMIDITY: 60/100%

SNOW TEMP: -9°/-2° C
HUMIDITY: 60/100%

SNOW TEMP: -3°/0° C
HUMIDITY: 60/100%

High fluorinated liquid paraffin for racing use as final product or as a base before applying fluorocarbon waxes FP4.

HP3 COLD Use for any type of snow from -22°C to -8°C. Air humidity from 60% to 100%.
HP3 MED Use for any type of snow from -9°C to -2°C. Air humidity from 60% to 100%
HP3 HOT Use for any type of snow from -3°C to 0°C. Air humidity from 60% to 100%.

Use cold application with manual cork and manual brush.

LIQUID SKIWAX
FLUORINATED PARAFFIN

PRODUCTS

LP2 COLD

CODE: MW0980N - 75 ml
CODE: MW0983N - 150 ml
CODE: MW0986N - 0,5 lt

LP2 MED

CODE: MW0981N - 75 ml
CODE: MW0984N - 150 ml
CODE: MW0987N - 0,5 lt

LP2 HOT

CODE: MW0982N - 75 ml
CODE: MW0985N - 150 ml
CODE: MW0988N - 0,5 lt

USE

SNOW TEMP: -22°/-8° C
HUMIDITY: 30/60%

SNOW TEMP: -9°/-2° C
HUMIDITY: 30/60%

SNOW TEMP: -3°/0° C
HUMIDITY: 30/60%

Fluorinated liquid paraffin for racing use as final product or as a base before applying fluorocarbon waxes FP4.

LP2 COLD Use for any type of snow from -22°C to -8°C. Air humidity from 30% to 60%.
LP2 MED Use for any type of snow from -9°C to -2°C. Air humidity from 30% to 60%.
LP2 HOT Use for any type of snow from -3°C to 0°C. Air humidity from 30% to 60%.

Use cold application with manual cork and manual brush.

LIQUID SKIWAX
HYDROCARBON PARAFFIN

PRODUCTS

BP1 COLD

CODE: MW0830 - 75 ml
CODE: MW0833 - 150 ml
CODE: MW0836 - 0,5 lt

BP1 MED

CODE: MW0831 - 75 ml
CODE: MW0834 - 150 ml
CODE: MW0837 - 0,5 lt

BP1 HOT

CODE: MW0832 - 75 ml
CODE: MW0835 - 150 ml
CODE: MW0838 - 0,5 lt

USE

SNOW TEMP: -22°/-8° C
HUMIDITY: <40%

SNOW TEMP: -9°/-2° C
HUMIDITY: <40%

SNOW TEMP: -3°/0° C
HUMIDITY: <40%

Liquid paraffin for training use and leisure.

BP1 COLD Use for any type of snow from -22°C to -8°C. Racing use with air humidity < 40%.
BP1 MED Use for any type of snow from -9°C to -2°C. Racing use with air humidity < 40%. It can be used as universal training product.
BP1 HOT Use for any type of snow from -3°C to 0°C. Racing use with air humidity < 40%.

Use cold application with manual cork and manual brush.



PRODUCTS

LIQUID SKIWAX
GLIDING LIQUID KIT

BP1 KIT 3 x 75 ml

CODE: MW0839

Liquid paraffin for training use and leisure.

BP1 COLD Use for any type of snow from -22°C to -8°C. Racing use with air humidity < 40%.
BP1 MED Use for any type of snow from -9°C to -2°C. Racing use with air humidity < 40%. It can be used as universal training product.
BP1 HOT Use for any type of snow from -3°C to 0°C. Racing use with air humidity < 40%.

Use cold application with manual cork and manual brush.

BP1 COLD KIT

CODE: MW0201

SNOW TEMP: -22°/-8° C
HUMIDITY: <40%



• Kit with MTO111 (cork/nylon brush)

BP1 MED KIT

CODE: MW0202

SNOW TEMP: -9°/-2° C
HUMIDITY: <40%



• Kit with MTO111 (cork/nylon brush)

BP1 HOT KIT

CODE: MW0203

SNOW TEMP: -3°/0° C
HUMIDITY: <40%



• Kit with MTO111 (cork/nylon brush)

UNIVERSAL FLUORO

CODE: MW0200N



• Kit with MTO111 (cork/nylon brush)

SKIN & GLIDE TOP KIT

CODE: MW0206

Kit with:
MW0830 (BP1 Cold 75 ml) Snow Temp. -22°C to -8°C. Air humidity < 40%.
MW0831 (BP1 Med 75 ml) Snow Temp. -9°C to -2°C. Air humidity < 40%.
MW0832 (BP1 Hot 75 ml) Snow Temp. -3°C to 0°C. Air humidity < 40%.
MW0755 (Clean 150 ml)
MTO900 (Fiberlene tape)
MTO111 (cork/nylon brush)

High quality universal liquid paraffin for training, sporting use and leisure. Thanks to the different wax versions included in this kit, it can be used for all type of snow. The product has a felt cap applicator to allow a quick waxing "last minute" operation with great gliding and long lasting, on ski sole and even on skin skis. Otherwise the useful cork/nylon brush let allows to have a professional gliding result.



ALPINE/NORDIC/SNOWBOARD

SKI WAX

SUPER GLIDE WAX LINE



PRODUCTS

UNIVERSAL FLUORO
SUPER GLIDE WAX
DISPLAY BOX LIQUID

CODE: MW0718N
SIZE: 12 pz x 75 ml

USE

SNOW TEMP: -15°/ 0° C

High quality universal liquid paraffin for sporting use and leisure. Use for all type of snow. The product has a felt cap applicator to allow a quick waxing "last minute" operation with great gliding and long lasting.



PRODUCTS

UNIVERSAL FLUORO
SUPER GLIDE WAX
DISPLAY BOX CREAM

CODE: MW0724N
SIZE: 12 pz x 75 ml

USE

SNOW TEMP: -15°/ 0° C

High quality universal low fluoro glide wax. Ideal for sporting and leisure in all conditions. Quick application with the sponge-cap included by rubbing and pressing. Then for best results polish the base with a horsehair or nylon brush.



PRODUCTS

UNIVERSAL FLUORO
SUPER GLIDE WAX
CREAM

CODE: MW0722N
SIZE: 250 ml

USE

SNOW TEMP: -15°/ 0° C

High quality universal low fluoro glide wax. Ideal for sporting and leisure in all conditions. Quick application with the sponge included by rubbing and pressing. Then for best results polish the base with a horsehair or nylon brush.



PRODUCTS

UNIVERSAL FLUORO
SUPER GLIDE WAX
SOLID

CODE: MW0728N
SIZE: 100 gr

USE

SNOW TEMP: -15°/ 0° C
APPLICATION: 130°/ 140° C

Universal all temperature high quality paraffin glide wax for sporting and leisure in all conditions. Use hot application with the waxing iron at 130°/140°C. Also ideal for rub-on and go application!



ALPINE/NORDIC/SNOWBOARD

SKI WAX

UNI VER SAL WAX LINE



UNIVERSAL SOLID
UNIVERSAL WAX LINE

Universal solid paraffin for sporting use and leisure. Use for all type of snow, not moist and wet, with temperature from -15°C to -5°C. It's a product especially suitable for rentals and laboratories. Use hot application with the waxing iron at 130°/140°C or with professional waxing machines.

PRODUCTS
RED
CODE: MW0700 - 100 gr
CODE: MW0702 - 1 kg

USE
SNOW TEMP: -15°/-5° C
APPLICATION: 130°/140° C ☺



UNIVERSAL SOLID
UNIVERSAL WAX LINE

Universal solid paraffin for sporting use and leisure. Use for all type of moist and wet snow, with temperature from -5°C to 0°C. It's a product especially suitable for rentals and laboratories. Use hot application with the waxing iron at 110°/120°C or with professional waxing machines.

PRODUCTS
YELLOW
CODE: MW0701 - 100 gr
CODE: MW0703 - 1 kg

USE
SNOW TEMP: -5°/ 0° C
APPLICATION: 110°/120° C ☺



UNIVERSAL SOLID FLUORINATED
UNIVERSAL WAX LINE

Universal fluorinated solid paraffin for sporting use and leisure. Use for all type of snow, not moist and wet, with temperature from -15°C to -5°C. It's a product especially suitable for rentals and laboratories. Use hot application with the waxing iron at 130°/140°C or with professional waxing machines.

PRODUCTS
RED FLUORO
CODE: MW0705N - 100 gr
CODE: MW0707N - 1 kg

USE
SNOW TEMP: -15°/-5° C
APPLICATION: 130°/140° C ☺



UNIVERSAL SOLID FLUORINATED
UNIVERSAL WAX LINE

Universal fluorinated solid paraffin for sporting use and leisure. Use for all type of moist and wet snow, with temperature from -5°C to 0°C. It's a product especially suitable for rentals and laboratories. Use hot application with the waxing iron at 110°/120°C or with professional waxing machines.

PRODUCTS
YELLOW FLUORO
CODE: MW0706N - 100 gr
CODE: MW0708N - 1 kg

USE
SNOW TEMP: -5°/ 0° C
APPLICATION: 110°/120° C ☺



UNIVERSAL BACKSHOP
GRANULAR AND SOLID WAX
COLD

CODE: MW0709 - 1 Kg
CODE: MW0710 - 5 kg
CODE: MW0712 - 20 kg

SNOW TEMP: -15°/ -5° C

Universal solid and granular paraffin for all type of winter snow, not moist and wet, from temperature -15°C to -5°C. It's a product especially suitable for rentals and laboratories. Use hot application with professional waxing machines.



UNIVERSAL LIQUID
UNIVERSAL WAX LINE

UNIVERSAL BACKSHOP
GRANULAR AND SOLID WAX
HOT

CODE: MW0714 - 1 Kg
CODE: MW0711 - 5 kg
CODE: MW0713 - 20 kg

SNOW TEMP: -5°/ 0° C

Universal solid and granular paraffin for all type of moist and wet snow from temperature -5°C to 0°C. It's a product especially suitable for rentals and laboratories. Use hot application with professional waxing machines.

PRODUCTS
UNIVERSAL LIQUID

CODE: MW0715 - 1 lt
CODE: MW0716 - 4.9 lt

Universal liquid paraffin for sporting use and leisure. Use for all type of snow. It's a product especially suitable for rentals and laboratories. Use cold application with brush and manual cork.



ANTI ICE
UNIVERSAL WAX LINE

PRODUCTS
ANTI ICE
CODE: MW0732
SIZE: 150 ml

Special silicone spray made to prevent the grip waxes from freezing or to avoid ice formation on the kick zone of no-wax ski. It's also useful to avoid ice formation on the serigraphy and the side of any type of ski. Cold application.



ALPINE/NORDIC/SNOWBOARD

SKI ALP WAX LINE



PRODUCTS

UNIVERSAL TOUR TOURING SKIN & BASE WAX DISPLAY BOX LIQUID

CODE: MW0747
SIZE: 12 pz x 75 ml

USE

SNOW TEMP: -15°/ 0° C

High quality universal liquid paraffin for sporting use on ski-alp skins and ski bases with every kind of snow. The product has a felt cap applicator that allows quick cold "last minute" waxing with great gliding and long lasting.



PRODUCTS

UNIVERSAL TOUR RACING SKIN WAX BLUE BOOST RUB-ON

CODE: MW0748N
SIZE: 20 gr

USE

SNOW TEMP: -20°/ -5° C
APPLICATION: 150° C ☞

Fluorocarbon special solid mix for waxing ski-alp racing skins. Use for every cold snow from -20°C to -5°C. Recommended cold application by rubbing over the skin. To obtain even higher durability some quick passages with waxing iron at 150° C can be made (exclusively on pure mohair skins).



PRODUCTS

UNIVERSAL TOUR RACING SKIN WAX RED BOOST RUB-ON

CODE: MW0749N
SIZE: 20 gr

USE

SNOW TEMP: -5°/ 0° C
APPLICATION: 150° C ☞

Fluorocarbon special solid mix for waxing ski-alp racing skins. Use for every warm and wet snow from -5°C to 0°C. Recommended cold application by rubbing over the skin. To obtain even higher durability some quick passages with waxing iron at 150° C can be made (exclusively on pure mohair skins).



PRODUCTS

UNIVERSAL TOUR TOURING SKIN & BASE WAX UNIVERSAL SKIN SPRAY

CODE: MW0745
SIZE: 250 ml

USE

SNOW TEMP: -15°/ 0° C

Universal spray polymer for skin protection from icing and dirt, improving gliding properties. For all snow conditions.



SKI WAX

NORDIC

GRIP WAX

LINE



PRODUCTS

**GRIPWAX BASE
ORANGE S10**

CODE: MWOS10
SIZE: 45 gr

USE

AIR TEMP: - ALL AIR TEMP - STICKBASE

Stick base to be used always as first layer of solid waxes with fine falling snow and new aggressive snow little transformed or mixed with artificial snow. It works with every air temperature.

PRODUCTS

**GRIPWAX
GREEN S11**

CODE: MWOS11
SIZE: 45 gr

USE

AIR TEMP: -16°/-8° C

Stick wax to be used with fine falling snow and new aggressive snow little transformed or mixed with artificial snow. It works with air temperature from -16°C to -8°C.

PRODUCTS

**GRIPWAX
DARK BLUE S12**

CODE: MWOS12
SIZE: 45 gr

USE

AIR TEMP: -10°/-6° C

Stick wax to be used with fine falling snow and new snow little transformed or mixed with artificial snow. It works with air temperature from -10°C to -6°C.

PRODUCTS

**GRIPWAX
LIGHT BLUE S13**

CODE: MWOS13
SIZE: 45 gr

USE

AIR TEMP: -5°/-3° C

Stick wax to be used with fine falling snow and new snow little transformed or mixed with artificial snow. It works with air temperature from -5°C to -3°C.

PRODUCTS

**GRIPWAX
DARK VIOLET S14**

CODE: MWOS14
SIZE: 45 gr

USE

AIR TEMP: -3°/-1° C

Stick wax to be used with fine falling snow and new snow little transformed or mixed with artificial snow. It works with air temperature from -3°C to -1°C.

PRODUCTS

**GRIPWAX
LIGHT VIOLET S15**

CODE: MWOS15
SIZE: 45 gr

USE

AIR TEMP: -2°/+1° C

Stick wax to be used with fine falling snow and new snow little transformed or mixed with artificial snow. It works with air temperature from -2°C to +1°C.

PRODUCTS

**GRIPWAX
RED S16**

CODE: MWOS16
SIZE: 45 gr

USE

AIR TEMP: 0°/+4° C

Stick wax to be used with falling snow and new snow or mixed with artificial snow. It works with air temperature from 0°C to +4°C.



PRODUCTS

**GRIPWAX BASE
GREEN K10**

CODE: MWOK10
SIZE: 60 gr

USE

AIR TEMP: -7°/-1° C

Klister to be used with transformed snow with big crystals and with icy coarse snow or mixed with artificial snow. It works with air temperature from -7°C to -1°C. Moreover it must always be used as first layer (base klister) for all klister wax with any temperature.

PRODUCTS

**GRIPWAX
BLUE K11**

CODE: MWOK11
SIZE: 60 gr

USE

AIR TEMP: -4°/0° C

Klister to be used with transformed snow with big crystals and with icy coarse snow or mixed with artificial snow. It works with air temperature from -4°C to 0°C.

PRODUCTS

**GRIPWAX
VIOLET K12**

CODE: MWOK12
SIZE: 60 gr

USE

AIR TEMP: -3°/+3° C

Klister to be used with transformed snow with big crystals and with icy coarse snow or mixed with artificial snow. It works with air temperature from -3°C to +3°C.

PRODUCTS

**GRIPWAX
RED K13**

CODE: MWOK13
SIZE: 60 gr

USE

AIR TEMP: -1°/+4° C

Klister to be used with transformed snow with big crystals and with icy coarse and wet snow or mixed with artificial snow. It works with air temperature from -1°C to +4°C.

PRODUCTS

**GRIPWAX BASE
SILVER K14**

CODE: MWOK14
SIZE: 60 gr

USE

AIR TEMP: 0°/+5° C

Silver Klister to be used with transformed snow or mixed with artificial snow with big and medium crystals. It works with air temperature from 0°C to +5°C. Very good to reduce friction and speed up sliding on very abrasive snow.

PRODUCTS

**GRIPWAX
UNIVERSAL K15**

CODE: MWOK15
SIZE: 60 gr

USE

AIR TEMP: -5°/+5° C

Universal Klister to be used with transformed snow or mixed with artificial snow with big crystals transforming from wet to icy. It works with air temperature from -5°C to +5°C and it avoids ice formation.

PRODUCTS

**GRIPWAX
KIT**

CODE: MWOSK050

1pc: MWOS13
1pc: MWOS14
1pc: MWOS15

1pc: MWOK15

1pc: MT0113
1pc: MT0510

A close-up photograph of a person's hands using a hand tool with a white cylindrical attachment. The person is wearing a brown jacket and a grey glove. The background is a workshop with various tools and equipment, including a red pot and a white container. The text "TOOLS AND ACCESSORIES" is overlaid on the right side of the image in a large, white, sans-serif font.

TOOLS AND AC CE SOR IES

NEW MAPLUSTEX ROLLERS

Who has never struggled to speed up skis after grinding them?
Or to remedy damages due to very abrasive and coarse snow or too high iron temperature?
For solving all these situations you must choose new MaplusTex rollers.

Thanks to their open, three-dimensional structure of special synthetic fibres, they allow:

- to speed up ski sole and to eliminate microhairs after a new structuring with grinding machine;
- to remove from ski sole the opacity following the use of a waxing iron utilized at too high temperatures;
- to eliminate micro-waves created when sliding on very abrasive or icy snow;
- to remove residues of a very hard wax (as Maplus Artic Base solid).

CATALOG 2020
2021

MAPLUS
ARTIC
BASE

MAPLUS
GENERAL CATALOG 2020/21



**TOOLS
AND ACCESSORIES**
MAPLUSTEX FINE

CODE: MTO090RS
LENGHT : 10 cm - DIAMETER 11 cm

Thanks to its abrasive microlamine, it allows to speed up ski sole in really short time – just three passages are recommended – after new structuring with grinding machine. It also rejuvenates ski sole from opacity due to very abrasive or icy snow or after using an overtemperated waxing iron.



**TOOLS
AND ACCESSORIES**
MAPLUSTEX EXTRA FINE

CODE: MTO095RS
LENGHT : 10 cm - DIAMETER 11 cm

Thanks to its special fibres, it is recommended for removing microhairs from nordic skis after new structuring or grinding up. It also gives the final touch to the skis speeding up done with MaplusTex Fine: three passages after using MaplusTex Fine guarantee the best final results. Specially indicated for removing residues of a very hard solid wax, as Maplus Artic Base solid.

HOW TO USE TIPS

- having a larger diameter than normal rotating brushes, they must be used with minimum pressure at a maximum drill speed of 700/800 revolutions per minute (rpm);
- it is preferable to use them before preparing the edges, in order to avoid rounding off the cusps;
- after using MaplusTex rollers it is recommended to thoroughly clean the base with a specific liquid cleaner, as Maplus Clean, so to remove any residues.

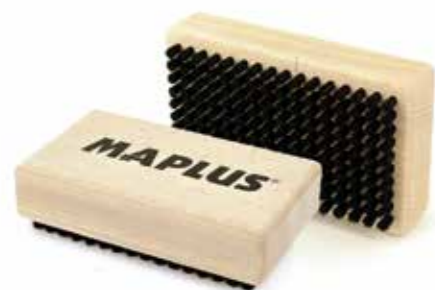

PRODUCTS
MANUAL BRUSH
HARD HORSEHAIR
CODE: MTO101
SOFT HORSEHAIR
CODE: MTO104

To be used for deep brushing of any type of paraffin and perfluorinated wax.

To be used for fine brushing of any type of paraffin and perfluorinated wax.

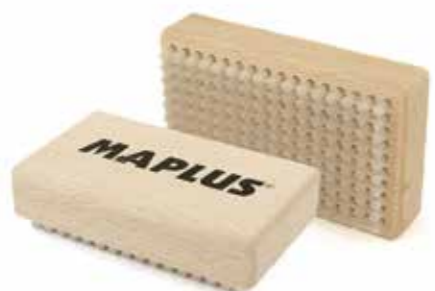

PRODUCTS
MANUAL BRUSH
HARD NYLON
CODE: MTO105
SOFT NYLON
CODE: MTO102

To be used with front and back movements for surface brushing and polishing of any type of paraffin and perfluorinated wax.

To be used for deep polishing of any type of paraffin and perfluorinated wax.

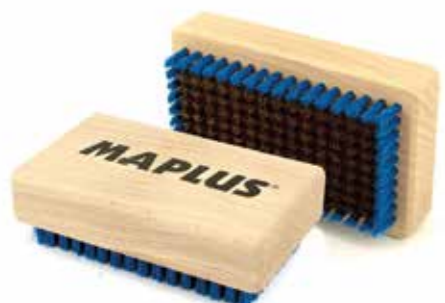

PRODUCTS
MANUAL BRUSH
HARD BRASS
CODE: MTO106

To be used for first brushing of any type of soft and med paraffin.

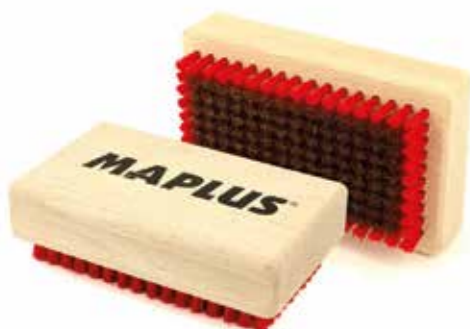

PRODUCTS
MANUAL BRUSH
SOFT BRASS
CODE: MTO103

To be used for smooth brushing of any type of soft and med paraffin and during the polyethylene-base cleaning operations.



PRODUCTS
MANUAL BRUSH
SOFT STEEL
CODE: MTO107

To be used for smooth brushing of any type of hard paraffin and during the polyethylene-base cleaning operations.



PRODUCTS
MANUAL BRUSH
HARD HORSEHAIR
CODE: MTO121
SOFT HORSEHAIR
CODE: MTO124

To be used for deep brushing of any type of paraffin and perfluorinated wax.

To be used for fine brushing of any type of paraffin and perfluorinated wax.



PRODUCTS
MANUAL BRUSH
HARD NYLON
CODE: MTO125
SOFT NYLON
CODE: MTO122

To be used with front and back movements for surface brushing and polishing of any type of paraffin and perfluorinated wax.

To be used for deep polishing of any type of paraffin and perfluorinated wax.



PRODUCTS
MANUAL BRUSH
HARD BRASS
CODE: MTO126

To be used for first brushing of any type of soft and med paraffin.



PRODUCTS
MANUAL BRUSH
SOFT BRASS
CODE: MTO123

To be used for smooth brushing of any type of soft and med paraffin and during the polyethylene-base cleaning operations.



PRODUCTS
MANUAL BRUSH
HARD STEEL
CODE: MTO128
Angled wire
SOFT STEEL
CODE: MTO127

To be used for first brushing of any type of hard paraffin and for speeding up polyethylene ski sole during its saturation.

To be used for smooth brushing of any type of hard paraffin and during the polyethylene-base cleaning operations.

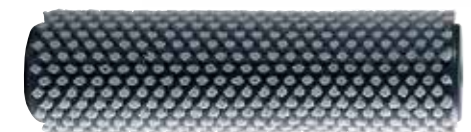

PRODUCTS

ROTO BRUSH

HORSEHAIR

CODE: MTO012 - 10 cm
CODE: MTO042 - 14 cm
CODE: MTO014 - 20 cm

To be used for deep brushing of any type of paraffin and perfluorinated wax on cross-country and alpine ski as well as snowboard.

PRODUCTS

ROTO BRUSH

NYLON

CODE: MTO013 - 10 cm
CODE: MTO043 - 14 cm
CODE: MTO015 - 20 cm

To be used for polishing of any type of paraffin and perfluorinated wax on cross-country and alpine ski as well as snowboard.

PRODUCTS

ROTO BRUSH

BRASS

CODE: MTO011 - 10 cm
CODE: MTO018 - 20 cm

To be used for first brushing of soft and med paraffin on cross-country and alpine ski as well as snowboard.

PRODUCTS

ROTO BRUSH

STEEL

CODE: MTO017 - 10 cm
CODE: MTO019 - 20 cm

To be used for first brushing of hard paraffin on cross-country and alpine ski as well as snowboard.

PRODUCTS

ROTO BRUSH

CORK

CODE: MTO022 - 10 cm
CODE: MTO024 - 14 cm

To be used for FP4 perfluorinated wax application.

PRODUCTS

ROTO BRUSH

XC COMBI 1

CODE: MTO049 - 14 cm

To be used for deep brushing and polishing of any type of paraffin on cross-country ski.



PRODUCTS

ROTO BRUSH

QUICK GRIP

CODE: MTO030



PRODUCTS

ROTO BRUSH

NOMIC GRIP

CODE: MTO040

PRODUCTS

MANUAL BRUSH

ROTO KIT 10 CM - CORK

CODE: MTO060 (MTO040 + MTO041 + MTO022-12-13)

PRODUCTS

MANUAL BRUSH

ROTO KIT 10 CM - BRASS

CODE: MTO065 (MTO040 + MTO041 + MTO011-12-13)

PRODUCTS

MANUAL BRUSH

ROTO KIT 10 CM - POLYESTER

CODE: MTO066 (MTO040 + MTO041 + MTO070-12-13)



PRODUCTS

ROTO BRUSH

QUIK DRIVE SHAFT

CODE: MTO031 - 10 cm
CODE: MTO032 - 14 cm
CODE: MTO033 - 20 cm

PRODUCTS

ROTO BRUSH

NOMIC DRIVE SHAFT

CODE: MTO041 - 10 cm
CODE: MTO047 - 14 cm
CODE: MTO048 - 20 cm



PRODUCTS

MANUAL BRUSH

ROTOBRUSH BOX

CODE: BMC0103
38x28x9 cm
only for 10 cm brushes

SPEED FABRIC ROLLERS



PRODUCTS
SPEED FABRIC ROLLERS
SPREADING ROLLER POLYESTER
 CODE: MTO070 - cm 10
 CODE: MTO075 - cm 14
 CODE: MTO080 - cm 20



PRODUCTS
SPEED FABRIC ROLLERS
BRUSHING ROLLER MERINO WOOL 5mm
 CODE: MTO081 - cm 20



PRODUCTS
SPEED FABRIC ROLLERS
POLISHING ROLLER MERINO WOOL 12mm
 CODE: MTO072N - cm 10
 CODE: MTO077N - cm 14
 CODE: MTO082N - cm 20



PRODUCTS
SPEED FABRIC ROLLERS
POLYESTER & MERINO WOOL ROTO SET CM 10
 CODE: MTO085N



PRODUCTS
SPEED FABRIC ROLLERS
POLYESTER & MERINO WOOL ROTO SET CM 14
 CODE: MTO086N



PRODUCTS
SPEED FABRIC ROLLERS
POLYESTER & MERINO WOOL ROTO SET CM 20
 CODE: MTO087N

Polyester and Merino wool rollers especially recommended for hot or cold application of every FP4 perfluorinated waxes (powder, spray or solid).

Instead of roto-cork and traditional horsehair and nylon brushes, use new rollers of polyester and merino wool as follows:

1. Roll the base surface with the roto-polyester in both directions at a speed between 1000 and 1500 rpm according to the pressure applied. Repeat several times until the complete saturation of the base surface. Wait at least 10 minutes for cooling of the base surface and for the ski wax to harden.

2. Free the base structure with the 5 mm. roto-wool.

3. Polish the base structure with the 12 mm. roto-wool.

For top performances is necessary one set of new rollers for every type of product (cold-med-hot).

WAXING IRONS



PRODUCTS
WAXING IRONS
ADJUSTABLE WAXING IRON T10B.15
 CODE: KZ05000N
 AC 220V
 MAX TEMP. 200°C

First choice waxing iron with easy temperature manual setting. Easy waxing in all directions due to ergonomic shape. Very competitive quality/price ratio.



PRODUCTS
WAXING IRONS
DIGITAL WAXING IRON T10A.15
 CODE: KZ06000N
 AC 220V
 MAX TEMP. 200°C

Professional powerfull digital waxing iron. The digital microprocessor controls temperature adjustment till 200°C. Inox iron plate guarantees a constant temperature of working. Easy waxing in all directions due to ergonomic shape.



PRODUCTS
WAXING IRONS
DIGITAL WAXING IRON T10A.35
 CODE: KZ03000N
 AC 220V
 MAX TEMP. 200°C

World Cup high professional waxing iron, with extremely precise digital temperature setting by digital microprocessor. The 35mm thick inox iron base guarantees the fully constant temperature. This iron wax is especially studied for handling all racing perfluorinated waxes which require stable and constant high temperature. Easy waxing in all directions due to ergonomic shape.



PRODUCTS
WAXING IRONS
ELECTRONIC IRON WAX
 CODE: KZ06001
 AC 110V
 MAX TEMP. 160°C
ONLY US AND JAPAN MARKET



PRODUCTS
WAXING IRONS
IRON WAX
 CODE: KZ05001
 AC 110V
 MAX TEMP. 160°C
ONLY US AND JAPAN MARKET



PRODUCTS
WAXING IRONS
FACIAL MASK
 CODE: KZ08000
 CE EN 136 - Class 3



PRODUCTS
WAXING IRONS
FILTER FOR FACIAL MASK
 CODE: KZ08001
 MSA A2-B2-E2-K1-HG-P3 CE

SKI FILES



Viiala skifile

PRODUCTS

SKI FILES

HARD CHROME FINE
CODE: ML0001 - 150 mm
CODE: ML0002 - 200 mm

Universal FINE file with hard-chromed surfaces: satisfied the technical requirements of professional skimen

PRODUCTS

SKI FILES

HARD CHROME COARSE
CODE: BK00010 - 150 mm
CODE: ML0003 - 200 mm

Universal COARSE file, with hard-chromed surfaces: satisfied the technical requirements of professional skimen

PRODUCTS

SKI FILES

HARD CHROME SUPER COARSE
CODE: ML0004 - 200 mm

Universal SUPERCOARSE file, with hard-chromed surfaces: satisfied the technical requirements of professional skimen

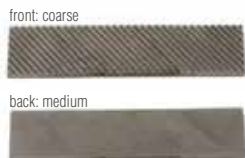

front: coarse

back: medium

PRODUCTS

SKI FILES

COMBI FILE MEDIUM - COARSE
CODE: ML0530 - 80 mm

Made of premium steel, this is the only ski file with two different cuts: a coarse cut on one side to provide an high and frank bite, and a medium cut on the other side to provide a fine tune on edge sharpening. Now with the same file it is possible to remove the excess of sidewall material, to sharpen damage edges and to refine edge sharpening with high precision. Its dimensions are adapted to most sharpeners of 80mm in length. With this combination, sharpening it is not only faster but also much more easy: every skis or snowboard will have a precise and powerful bite.



PRODUCTS

SKI FILES

FILE BRUSH
CODE: MT0100

The perfect brush for cleaning all kind of files



Viiala skifile

PRODUCTS

SKI FILES

BODY FILE
CODE: ML0005 - 300 mm

Radial file special studied for roughing skis and snowboards



PRODUCTS

SKI FILES

PROFESSIONAL HARD CHROME BASTARD
CODE: ML0501 - 200 mm

Due to their high level precision and performance, these files are considered as the reference by the world's most renowned professional skimen. They are chosen by the most demanding users for their smooth and consistent bite. Thanks to their chromed plates, these files are protected against corrosion.

PRODUCTS

SKI FILES

PROFESSIONAL HARD CHROME 2ND CUT
CODE: ML0502 - 200 mm

PRODUCTS

SKI FILES

PROFESSIONAL HARD CHROME SMOOTH
CODE: ML0503 - 150 mm



PRODUCTS

SKI FILES

PROFESSIONAL NO-CHROME BASTARD
CODE: ML0511 - 200 mm

Due to their high level precision and performance, these files are considered as the reference by the world's most renowned professional skimen. They are chosen by the most demanding users for their smooth and consistent bite.

PRODUCTS

SKI FILES

PROFESSIONAL NO-CHROME 2ND CUT
CODE: ML0512 - 200 mm

PRODUCTS

SKI FILES

PROFESSIONAL NO-CHROME SMOOTH
CODE: ML0513 - 150 mm



PRODUCTS

SKI FILES

PRO RS NO-CHROME COARSE
CODE: ML0525 - 100 mm

PRODUCTS

SKI FILES

PRO RS NO-CHROME MEDIUM
CODE: ML0526 - 100 mm

PRODUCTS

SKI FILES

PRO RS NO-CHROME FINE
CODE: ML0527 - 100 mm

These files benefit from ideal dimensions and fit to a very precise sharpening. Produced with a premium steel in order to assure a consistent quality to the product, These files are optimized for an exceptional biting and do not clog.

DIAFACE - DIAMOND - STONES

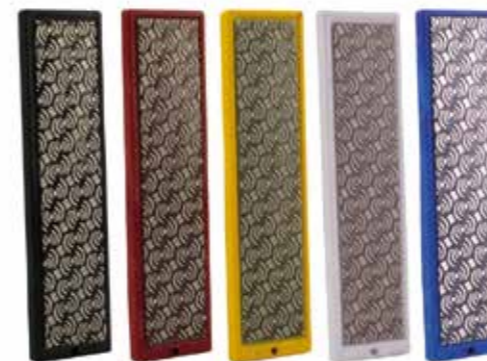

PRODUCTS

DIAFACE

DIAFACE 100 gr
CODE: MP0210 - 70 mm
MP0200 - 100 mm

DIAFACE 400 gr
CODE: MP0212 - 70 mm
MP0202 - 100 mm

DIAFACE 1000 gr
CODE: MP0214 - 70 mm
MP0204 - 100 mm

DIAFACE 200 gr
CODE: MP0211 - 70 mm
MP0201 - 100 mm

DIAFACE 600 gr
CODE: MP0213 - 70 mm
MP0203 - 100 mm



PRODUCTS

DIAMOND

WORLD CUP DIAMOND 100 gr
CODE: MP0310 - 70 mm
MP0300 - 100 mm

WORLD CUP DIAMOND 400 gr
CODE: MP0312 - 70 mm
MP0302 - 100 mm

WORLD CUP DIAMOND 1000 gr
CODE: MP0314 - 70 mm
MP0304 - 100 mm

WORLD CUP DIAMOND 200 gr
CODE: MP0311 - 70 mm
MP0301 - 100 mm

WORLD CUP DIAMOND 600 gr
CODE: MP0313 - 70 mm
MP0303 - 100 mm



PRODUCTS

DIAFACE

MINI SQUARE 88°
CODE: MP0150
for diaface 70 mm

MINI SQUARE 87°
CODE: MP0151
for diaface 70 mm



PRODUCTS

STONES

NATURAL STONE
CODE: MP0002 - FINE
CODE: MP0003 - MEDIUM



PRODUCTS

STONES

GUMMY STONE ALLAROUND
CODE: MP0015



PRODUCTS

STONES

GUMMY STONE FINE
CODE: MP0010



PRODUCTS

STONES

ARKANSAS
CODE: MP0004 - EXTRA FINE



PRODUCTS

STONES

ALU OXIDE STONE
CODE: BK0006 MEDIUM



WAXING TOOLS
CORK/NYLON BRUSH
 CODE: MT0111
 75 x 55 x 34 mm



WAXING TOOLS
CORK/FELT PAD
 CODE: MT0115
 135 x 42 x 39 mm



WAXING TOOLS
FELT PAD
 CODE: MT0118
 135 x 42 x 39 mm



WAXING TOOLS
VELCRO® PAD
 CODE: MT0119
 135 x 42 x 39 mm



WAXING TOOLS
NORDIC SCRAPER
 CODE: MT0510
GROOVE SCRAPER
 CODE: MT0512



WAXING TOOLS
STEEL SCRAPER
 CODE: MT0513 - 1 mm



WAXING TOOLS
PLEXY SCRAPER
 CODE: MT0511
 130 x 60 x 4 mm
SNOWBOARD SCRAPER
 CODE: MT0515
 260 x 70 x 5 mm



WAXING TOOLS
PTFE TAPE
 CODE: MT0901
 10 mt x 130 mm
PTFE SHEET
 CODE: MT0902 - 10 pcs
 200 x 130 mm



WAXING TOOLS
STANDARD THERMOMETER
 CODE: MT0915
 temp. -20°/+50°



WAXING TOOLS
FIBERLENE TAPE
 CODE: MT0900
 10 mt x 130 mm



WAXING TOOLS
DIGITAL PROBE THERMOMETER
 CODE: MT0921
 temp. -40°/+200°



WAXING TOOLS
THERMO-HYGROMETER
 CODE: MT0923
 temp. -20°/+50°
 hr 10% / 95%



WAXING TOOLS
DIGITAL THERMO HYGROMETER
 CODE: MT0920
 temp. -40°/+70°
 hr. 1% / 99%



WAXING TOOLS
POWDER NET DISPENSER
 CODE: MT0905



WAXING TOOLS
THERMO WAXING COVER
 ALPINE - MT0801N - AC 220V
 ALPINE - MT0801NUS - AC 110V

55°C - 60°C - 2300 x 140 mm
 55°C x 1,5 h for quick ski base saturation

THERMO WAXING COVER
 FREERIDE - MT0805N - AC 220V
 FREERIDE - MT0805NUS - AC 110V

55°C - 60°C - 2000 x 170 mm
 55°C x 1,5 h for quick ski base saturation

THERMO WAXING COVER
 SNOWBOARD - MT0806N - AC 220V
 SNOWBOARD - MT0806NUS - AC 110V

55°C - 60°C - 1800 x 330 mm
 55°C x 1,5 h for quick ski base saturation



WAXING TOOLS
INFRARED THERMOMETER GUN
 CODE: MT0916
 temp. -33°/+500°



WAXING TOOLS
SKIMAN BOX
 CODE: BMC0100
 470 x 360 x 175 mm

WAXING TOOLS
WAXING THERMO BAG
 CODE: MT0800 - AC 220V
 2200 x 450 x 450 mm
 ADJUSTABLE TEMP: 30°C - 70°C



WAXING TOOLS
THERMO WAXING COVER JUMPING
 CODE: MT0801JP - AC 220V

55°C - 60°C - 3000 x 185 mm
 55°C x 2 h for quick ski base saturation



WAXING TOOLS
CLAMP FOR THERMO COVER
 CODE: MT0802

PRODUCTS
SKILAB
 ACCESSORIES
PROTECTIVE MASK
 CODE: KZ08005



PRODUCTS
SKILAB
 ACCESSORIES
HOLE PLUGS
 CODE: LK21101 - 500 pcs
 MIXED NORMAL COLORS



PRODUCTS
SKILAB
 ACCESSORIES
STEEL SKI DRILL
 CODE: MM420L - 3,5 x 7 mm
 CODE: MM420L - 3,5 x 9 mm
 CODE: MM420L - 3,8 x 10 mm
 CODE: MM420L - 3,8 x 15 mm
 CODE: MM420L - 4,1 x 9 mm



PRODUCTS
SKILAB
 ACCESSORIES
SCREW DRIVER BIT
 CODE: MMF4302
 pzd2 x 110 mm - A4 standard
 CODE: MMF4303
 pzd3 x 110 mm - A4 standard



PRODUCTS
SKILAB
 ACCESSORIES
ELASTICS FOR BINDING
 CODE: SM058100 - 1 kg



PRODUCTS
SKILAB
 ACCESSORIES
STEEL STRUCTURE BRUSH
 CODE: BK00130



PRODUCTS
SKILAB
 ACCESSORIES
TRUE BAR
 CODE: MT0514 - 3 mm
 STEEL SCRAPER



PRODUCTS
SKILAB
 ACCESSORIES
PLASTIC BUSHING THREADED
 CODE: LK21201 - 100 pcs
 BLACK



PRODUCTS
SKILAB
 ACCESSORIES
HARD STEEL SKI DRILL
 CODE: MM420CO - 4,1 x 9 mm



PRODUCTS
SKILAB
 ACCESSORIES
LUBRICANT FOR SKI BINDINGS
 CODE: MM490 - 150 ml



PRODUCTS
SKILAB
 ACCESSORIES
SAND PAPER 70 x 200 mm
 CODE: BK00008 gr 600 - 5 pcs

SAND PAPER 120 x 200 mm
 CODE: BK00950 gr 180 - 5 pcs
 CODE: BK00951 gr 120 - 5 pcs



PRODUCTS
WAXING TOOLS
MAPLUSTEX KIT
 CODE: BK00009
 135 x 110 x 7 mm

three different abrasive mats for smoothing ski base



PRODUCTS
MAINTENANCE SOLES
SKI BASE
 CODE: LK00001 - transparent - 4pcs
 LK00002 - graphite - 4pcs
 250 x 80 x 1,3 mm



PRODUCTS
MAINTENANCE SOLES
GUN CANDLE ø 11.5 mm
 CODE: LK20301 - transparent
 LK20302 - graphite
 LK20303 - black



PRODUCTS
MAINTENANCE SOLES
WIRE FOR SMEARING MACHINE ø 3mm - 0.5 kg
 CODE: LK20601 - transparent
 LK20602 - graphite
 LK20607 - black



PRODUCTS
MAINTENANCE SOLES
METAL GRIP ø 3,5mm - 10 mt
 CODE: LK20902 - transparent
 LK20904 - graphite



PRODUCTS
MAINTENANCE SOLES
POLYMERIC ADHESIVE FOR SKI BASE REPAIRING
 CODE: LK00010 - amber - 25 ml
 LK00015 - black - 25 ml



PRODUCTS
MAINTENANCE SOLES
UNIVERSAL CYANOACRYLATE ADHESIVE
 CODE: LK00020 - transparent - 30 gr



PRODUCTS
MAINTENANCE SOLES
FREE CANDLE ø 8 mm
 CODE: LK20001 - transparent
 LK20002 - graphite
 LK20003 - black



PRODUCTS
MAINTENANCE SOLES
WELDING STRIP
 CODE: LK20401 - transparent
 LK20402 - graphite
 LK20403 - black



PRODUCTS
MAINTENANCE SOLES
WIRE FOR SMEARING MACHINE ø 3mm - 1.5 kg
 CODE: LK20661 - transparent
 LK20662 - graphite
 LK20667 - black



PRODUCTS
MAINTENANCE SOLES
MIXING TIPS
 CODE: LK00016 - 12 pcs



PRODUCTS
MAINTENANCE SOLES
PRIMER FOR POLYETHYLENE
 CODE: LK00021 - spray - 15 ml



PRODUCTS
SKI MAN
FOLDING TABLE

UNIVERSAL SKIMAN TABLE
CODE: MT0610 - 16,5 Kg
Bag included
L102 x W50 x H85 cm



PRODUCTS
SKI MAN
FOLDING TABLE

ALPINE SKIMAN TABLE PRO
CODE: MT0611 - 8 Kg
Aluminium light weight
L113 x W47 x H96 cm



PRODUCTS
SKI MAN
ACCESSORIES

XC PROFILE PRO
CODE: MT0613
Aluminium light weight
for table 611-612



PRODUCTS
SKI MAN
ACCESSORIES

SKI RACK
CODE: MT0614



PRODUCTS
SKI MAN
ACCESSORIES

CENTRAL CLIP
CODE: MT0617
for profile 613



PRODUCTS
SKI MAN
ACCESSORIES

IRON HOLDER
CODE: MT0620



PRODUCTS
SKI MAN
FOLDING TABLE

XC SKIMAN TABLE PRO
CODE: MT0612 - 11,5 Kg
Aluminium light weight
L213 x W47 x H92 cm



PRODUCTS
SKI MAN
FOLDING TABLE

UNIVERSAL DOUBLE BENCH
CODE: MT0630 - 19 Kg
L110 x W40 x H84 cm



PRODUCTS
SKI MAN
ACCESSORIES

RUBBISH BAG HOLDER
CODE: MT0621



PRODUCTS
SKI MAN
ACCESSORIES

XC PROFILE SET PRO
CODE: MT0623
Aluminium light weight



PRODUCTS
SKI MAN
FOLDING TABLE

TRAVEL BENCH
CODE: MT0640
L115 x W9,5 x H120 cm.
3,6 kg.



PRODUCTS
SKI MAN
ACCESSORIES

TABLE BAG
CODE: MT0608
for table 610
CODE: MT0628
for table 611-612



PRODUCTS
SKI MAN
ACCESSORIES

XC PROFILE SET
CODE: MT0635
L150 x W4 x H18 cm.
3,7 kg.
(ski from 140 to 210 cm.)

PRODUCTS

SKI AND SNOWBOARD VISE

SKI VISE QUICK

CODE: SM00690

- High-tensile aluminium body
- Light and easy to transport
- For tuning all types & shapes of skis
- Special rubber to grip the ski during base work
- Included 2 brake retainers



PRODUCTS

SKI AND SNOWBOARD VISE

SKI VISE 24 HOURS

CODE: SM00650

- High-tensile aluminium body
- Light and easy to transport
- For tuning all types & shapes of skis
- Special rubber to grip the ski during side and base work
- Included 2 brake retainers



PRODUCTS

SKI AND SNOWBOARD VISE

SKI SUPPORT

CODE: SM00695

- High-tensile aluminium body
- Light and easy to transport
- For tuning all types & shapes of skis
- Special rubber to grip the ski during base work
- Included 2 brake retainers



PRODUCTS

SKI AND SNOWBOARD VISE

BRAVO SUPPORT

CODE: SM00635
for SM00691-1070N-1110N-1110NW

- Universal adapter with special rubber to grip cross-country ski, snowboard & wide ski during the base tuning

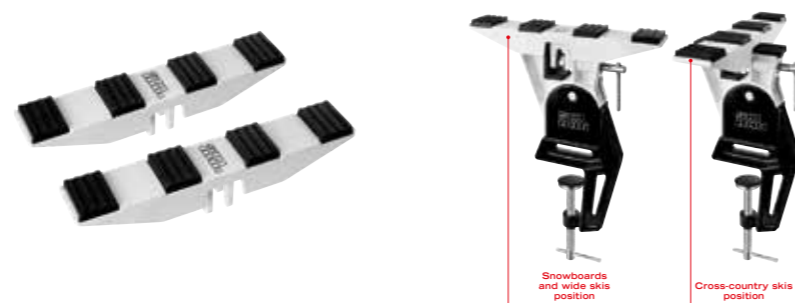

PRODUCTS

SKI AND SNOWBOARD VISE

SKI VISE COMP

CODE: SM00691
max opening 85 mm

- Jaw width 30 mm
- Jaw opening: up to 90 mm
- High-tensile aluminium body
- Light and easy to transport
- For tuning all types & shapes of skis
- Included 2 brake retainers



PRODUCTS

SKI AND SNOWBOARD VISE

SKI VISE RACING

CODE: SM01070N
max opening 100 mm

- Jaw width: 70 mm
- Jaw opening: up to 100 mm
- Rubber lined vice jaws
- Special rubber with small suction cups on the top grip of the supports
- Adjustable guide blocks
- For skis with all kinds of riser plates
- High tensile aluminum body
- Also use horizontally for mounting bindings
- Included 2 brake retainers
- Designed to clamp also in the plate or binding



PRODUCTS

SKI AND SNOWBOARD VISE

SKI VISE PRO

CODE: SM01110N
max opening 100 mm

- Jaw width 90 mm
- Jaw opening: up to 100 mm
- High-tensile aluminium body
- For tuning all types & shapes of skis
- Included 2 brake retainers
- Designed to clamp also in the plate or binding



PRODUCTS

SKI AND SNOWBOARD VISE

SKI VISE PRO "WIDE OPENING"

CODE: SM01110NW
max opening 155 mm

- Jaw width 90 mm
- Jaw opening: up to 155 mm
- High-tensile aluminium body
- For tuning all types & shapes of skis
- Included 2 brake retainers
- Designed to clamp also in the plate or binding



PRODUCTS

SKI AND SNOWBOARD VISE

SKI VISE CROSS COUNTRY WORLD CUP

CODE: SM00670N

- High-tensile aluminium body
- Light and practical for travelling
- For tuning all types & shapes of nordic skis



SKI AND SNOWBOARD VISE

SKI AND SNOWBOARD VISE

SKI VISE XXL
CODE: SM00994

- High-tensile aluminium body
- Jaw width 70 mm
- Jaws opening up to 155 mm



SKI AND SNOWBOARD VISE

SNOWBOARD - FREERIDE SKI VISE
CODE: SM01003N

- High-impact plastic body
- For tuning all types of snowboards and wide skis
- Special rubber to grip the snowboards and wide skis during side and base tuning
- Two side edge positions: standard 90° and easy 60°
- Binding clearance: 160 mm



SKI AND SNOWBOARD VISE

DOUBLE WORKSHOP VISE
CODE: SM01021N

- Professional workshop vise for working on the base, on the bindings and plates, and on the side edge of all kind of skis and snowboard



SKI AND SNOWBOARD VISE

DOUBLE WORKSHOP SUPPORT
CODE: SM01022N

- Professional workshop supports for working on the side edge of all kind of skis and snowboard

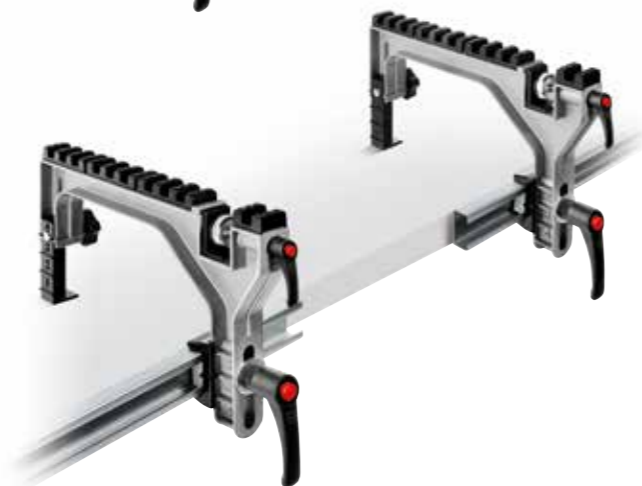

EDGE SHARPENERS

EDGE SHARPENERS

RACING SHARP
CODE: SM05006
Side edge: 89°-88°-87°-86° / Base edge: 0,5°- 1°

- Ergonomic side edge sharpener
- Easy handling, steady grip, maximum accuracy
- Best results, minimum effort
- Right and left hand use
- For ski and snowboard
- Spare file 80 mm SM05104



EDGE SHARPENERS

RACING SHARP KIT
CODE: SM05007

- Ergonomic side edge sharpener
- Easy handling, steady grip, maximum accuracy
- Best results, minimum effort
- Right and left hand use
- For ski and snowboard



EDGE SHARPENERS

QUICK SHARP 88°-89°
CODE: SM03007

- Ergonomic side edge sharpener
- Pocket size, «on the slope» use also
- Easy handling, steady grip, maximum accuracy
- Best results, minimum effort
- Right and left hand use
- For ski and snowboard
- Spare file 40 mm SM05105



EDGE SHARPENERS

QUICK SHARP KIT 88°-89°
CODE: SM03009

- Ergonomic side edge sharpener
- Pocket size, «on the slope» use also
- Easy handling, steady grip, maximum accuracy
- Best results, minimum effort
- Right and left hand use
- For ski and snowboard
- Spare file 40 mm SM05105



EDGE SHARPENERS

DIAMOND SHARP 88°-89°
CODE: SM04006N

- Ergonomic side edge sharpener
- Pocket size, «on the slope» use also
- Easy handling, steady grip, maximum accuracy
- Best results, minimum effort
- Right and left hand use
- For ski and snowboard
- Spare file 40 mm SM05190





EDGE SHARPENERS
SPARE DIAMOND DISC
CODE: SM05190



EDGE SHARPENERS
SPARE ZIRCONIUM
CODE: SM05140



EDGE SHARPENERS
SPARE DIAMOND
CODE: SM05160

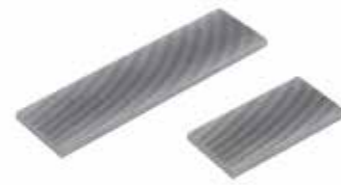

EDGE SHARPENERS
SPARE FILE BASTARD
CODE: SM05104 - 80 mm
SM05105 - 40 mm

PRODUCTS

EDGE SHARPENERS

PRO SHARP
CODE: SM05001
from 90° to 85°

- Professional side edge sharpener
- Easy handling, steady grip, maximum accuracy
- Best results, minimum effort
- Fits any files, stones or diamonds up to 6 mm thick
- Ball bearing system to protect the base
- Right and left hand use
- For ski and snowboard
- Spare file 80 mm included



PRODUCTS

EDGE SHARPENERS

ERGO SHARP
CODE: SM05002
from 90° to 85°

- Ergonomic side edge sharpener
- Easy handling, steady grip, maximum accuracy
- Best results, minimum effort
- Fits any files, stones or diamonds up to 6 mm thick
- Right and left hand use
- For ski and snowboard
- Spare file 80 mm included



PRODUCTS

EDGE SHARPENERS

PLEXI SHARP
CODE: SM00630N

- Wax scraper sharpener
- Used for 3, 4, 5 mm plexi wax scraper thick
- 100 mm body file included
- Spare 100 mm body file included



PRODUCTS

EDGE SHARPENERS

SPARE BODY FILE
CODE: SM05101



PRODUCTS

EDGE SHARPENERS

SIDEWALL SHARP
CODE: SM03004

- Ergonomic sidewall planer
- Easy handling, steady grip, maximum accuracy
- Best results, minimum effort
- Adjustable blade position and cutting depth
- Right and left hand use
- For ski and snowboard



PRODUCTS

EDGE SHARPENERS

SIDEWALL SHARP WORLD CUP
CODE: SM05005N

- Professional sidewall planer
- Easy handling, steady grip, maximum accuracy
- Best results, minimum effort
- Adjustable blade position and cutting depth
- Right and left hand use
- For ski and snowboard



SPARE BLADE STANDARD
CODE: SM05120



SPARE BLADE RADIUS 3 mm
CODE: SM05125



SPARE BLADE ROUND
CODE: SM05130



PRODUCTS

EDGE SHARPENERS

ADJUSTABLE BASE EDGE FILE GUIDE
CODE: SM03071
from 0,5° to 1,5°

- Base edge sharpener
- Easy handling, steady grip, maximum accuracy
- Best results, minimum effort
- Fits any files, stones or diamonds up to 6 mm thick
- For ski and snowboard



PRODUCTS

EDGE SHARPENERS

BASE EDGE FILE GUIDE
CODE: SM03051N - 0,5°
SM03052N - 0,75°
SM03053N - 1°

- Professional base edge sharpener
- Easy handling, steady grip, maximum accuracy
- Best results, minimum effort
- Fits any files, stones or diamonds up to 6 mm thick
- For ski and snowboard





EDGE SHARPENERS

RACING GUIDE

- CODE: SM03030 - 90°
 SM03031 - 89°
 SM03032 - 88°
 SM03033 - 87°
 SM03034 - 86°

- Side edge file guide with ergonomic clamp included
- Designed to eject metal filings
- Fits any files, stones or diamonds
- For ski and snowboard

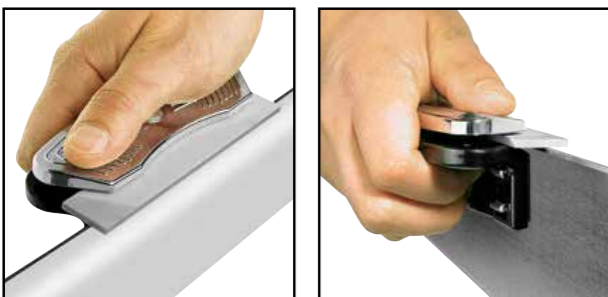

EDGE SHARPENERS

RACING GUIDE PLUS

- CODE: SM03040 - 90°
 SM03041 - 89°
 SM03042 - 88°
 SM03043 - 87°
 SM03044 - 86°

- Side edge file guide with clamp included
- Designed to eject metal filings
- Ball bearing system to protect the base
- Fits any files, stones or diamonds
- For ski and snowboard

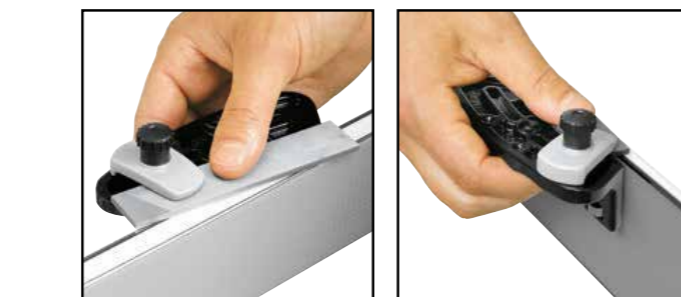

EDGE SHARPENERS

BRAVO SHARP

CODE: SM09001
 from 90° to 86°

Electric side edge sharpener for fast and professional sharpening of side edges of ski and snowboard.

Thanks to its innovative design, side edges can be prepared with considerably less effort than with conventional manual devices, even if side edges are severely damaged.

- 220 V (for european market only)
- Weight 1.3 kg

Including:
 DIAMOND DISC FINE
 DIAMOND DISC COARSE



STAINLESS STEEL PLATE

Easy angle setting between 90° and 85°

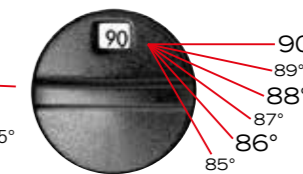

EDGE SHARPENERS

INOX SQUARE

- CODE: SQ0090 - 90°
 SQ0089 - 89°
 SQ0088 - 88°
 SQ0087 - 87°
 SQ0086 - 86°
 SQ0085 - 85°



ALUMINIUM SQUARE

- CODE: SQ0090V - 90°
 SQ0089V - 89°
 SQ0088V - 88°
 SQ0087V - 87°
 SQ0086V - 86°
 SQ0085V - 85°



EDGE SHARPENERS

SKI FILE CLAMP

CODE: MT0803



EDGE SHARPENERS

DIAMOND DISC COARSE

CODE: SM09002
 Angle set-up and deburring.



EDGE SHARPENERS

DIAMOND DISC MEDIUM

CODE: SM09003
 General maintenance.



EDGE SHARPENERS

DIAMOND DISC FINE

CODE: SM09004
 World Cup precise polishing.



EDGE SHARPENERS

DIAMOND DISC EXTRA FINE

CODE: SM09005
 Super fine polishing.



PRODUCTS

NORDIC STRUCTURE

NORDIC SHARP
CODE: SM08001
Art. SM08006 included

- Ergonomic structuring tool with interchangeable structure rollers
- Easy handling, steady grip, maximum accuracy
- Best results, minimum effort
- According to the snow conditions, it will increase the glide of the skis
- Delivered with a medium diagonal roller

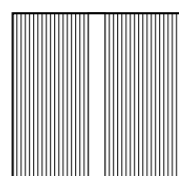
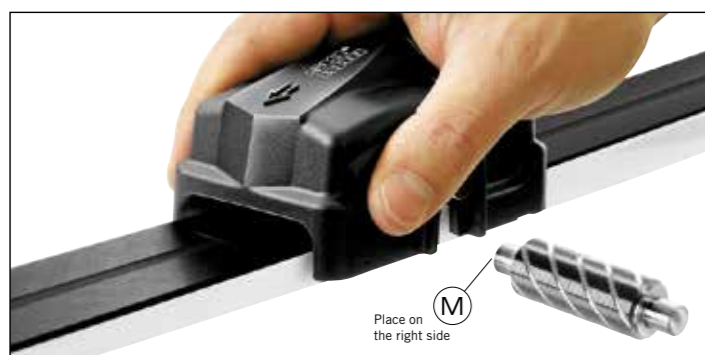

PRODUCTS

NORDIC STRUCTURE

LINEAR COARSE
CODE: SM08002
for warm and wet conditions

LINEAR MEDIUM
CODE: SM08003
for universal conditions

LINEAR FINE
CODE: SM08004
for cold conditions

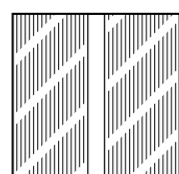

PRODUCTS

NORDIC STRUCTURE

DIAGONAL COARSE
CODE: SM08005
for warm and wet conditions

DIAGONAL MEDIUM
CODE: SM08006
for universal conditions

DIAGONAL FINE
CODE: SM08007
for cold conditions

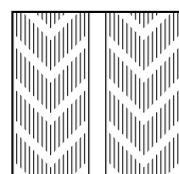

PRODUCTS

NORDIC STRUCTURE

W COARSE
CODE: SM08008
for warm and wet conditions

W MEDIUM
CODE: SM08009
for universal conditions

W FINE
CODE: SM08010
for cold conditions

PRODUCTS

HOTBOX WAXING MACHINE

HOTBOX 140
CODE: SV00001
DIMENSIONS: 205X198X100 mm
WEIGHT: 3 kg
VOLTAGE: 220V/50HZ
AVAILABLE AT: 110V
ABSORPTION: 0.7 Kw
OPERATING TEMP.: 110° - 140° C
ROLLER WIDTH: 120 mm



PRODUCTS

HOTBOX ACCESSORIES

140 TANK WITH STANDARD ROLLER
CODE: SV00002

140 TANK WITH CROSS COUNTRY ROLLER
CODE: SV00003
Thin + Thick Layer

160 TANK WITH STANDARD ROLLER
CODE: SV00011

350 TANK WITH SILICON ROLLER
CODE: SV00009



HOTBOX ACCESSORIES

140 TANK WITH SKI WAX SCRAPERS
CODE: SV00004

HOTBOX ACCESSORIES

140 TANK COVER
CODE: SV00006

160 TANK COVER
CODE: SV00012



HOTBOX 160
CODE: SV00010

DIMENSIONS: 225X198X100 mm
WEIGHT: 4 kg
VOLTAGE: 220V/50HZ
AVAILABLE AT: 110V
ABSORPTION: 0.7 Kw
OPERATING TEMP.: 110° - 140° C
ROLLER WIDTH: 150 mm



PRODUCTS

HOTBOX WAXING MACHINE

GRIP WAX DIGITAL HOTBOX
CODE: SV00013

DIMENSIONS: 205X198X100 mm
WEIGHT: 4 kg
VOLTAGE: 220V/50HZ
AVAILABLE AT: 110V
ABSORPTION: 0.7 Kw
OPERATING TEMP.: 50° - 200° C
ROLLER WIDTH: 100 mm

PRODUCTS

HOTBOX ACCESSORIES

GRIP WAX TANK WITH ROLLERS
CODE: SV00014



PRODUCTS

MOTOBURSH ACCESSORIES

PLEXY SCRAPER
CODE: SV00030N



PRODUCTS

HOTBOX ACCESSORIES

HERMETIC BOX WITH FOAM PROTECTION
CODE: SV00007 - L55xW42xH30 cm
CODE: SV00008 - L68xW52xH37 cm





ROTO WAXING & BRUSHING MACHINE
MOTO BRUSH 2 WITHOUT ROLLERS
 CODE: SV00020N
 1 HEATING PLATE

Professional waxing and brushing machine with one heating plate and replaceable rollers.

DIMENSIONS: 590X160X215 MM
 WEIGHT: 15 KG
 VOLTAGE 220V/50HZ
 ABSORPTION 0.5 KW



ROTO WAXING ACCESSORIES
ROLLER FOR MERINO WOOL LEATHER
 CODE: SV00029 - 14 cm



ROTO WAXING ACCESSORIES
SCOTCH BRITE ROLLER
 CODE: SV00027 - 16 cm



ROTO WAXING ACCESSORIES
HORSEHAIR BRUSH 10 mm
 CODE: SV00023 - 16 cm



ROTO WAXING ACCESSORIES
NYLON/HORSEHAIR BRUSH 10 mm
 CODE: SV00026 - 16 cm



ROTO WAXING ACCESSORIES
MERINO WOOL LEATHER
 CODE: SV00021 - 14 cm



ROTO WAXING ACCESSORIES
BRASS BRUSH 13 mm
 CODE: SV00022 - 16 cm



ROTO WAXING ACCESSORIES
NYLON BRUSH 10 mm
 CODE: SV00024 - 16 cm



MOTOBRUSH ACCESSORIES
WORK BASE HIGH STABILITY WORK BASE WITH DOOR AND SHELVES FOR HOT BOX AND MOTO BRUSH 2
 CODE: SV00040



BAG & ACCESSORIES
RACING BACK PACK
 CODE: MB0300



BAG & ACCESSORIES
ALPINE BACK PACK
 CODE: MB0310



BAG & ACCESSORIES
TRAVELLER TROLLEY
 CODE: MB0200 - 90lt



BAG & ACCESSORIES
TEAM WHEEL BAG
 CODE: MB0205 - 70lt



BAG & ACCESSORIES
SKITUBE
 CODE: MB0400
 3 xc ski - 1 alpine ski



BAG & ACCESSORIES
SKIBAG
 CODE: MB0405
 3 xc ski - 1 alpine ski



BAG & ACCESSORIES
WHEEL SKIBAG PRO
 CODE: MB0410
 6 xc ski - 3 alpine ski



PRODUCTS

ACCESSORIES
MERCHANDISING

SYNTHETIC DOWN JACKET

CODE: MA0322
S - M - L - XL - XXL



PRODUCTS

ACCESSORIES
MERCHANDISING

BUTTON NECK SHIRT

CODE: MA0009 - Short sleeves
MA0019 - Long sleeves
S - M - L - XL - XXL



PRODUCTS

ACCESSORIES
MERCHANDISING

XC COVER JACKET - UNISEX

CODE: MA079005U
XS - S - M - L - XL - XXL



PRODUCTS

ACCESSORIES
MERCHANDISING

XC COVER GILET - UNISEX

CODE: MA079006U
XS - S - M - L - XL - XXL



PRODUCTS

ACCESSORIES
MERCHANDISING

SKIMAN APRON COTTON

CODE: MA0003J



PRODUCTS

ACCESSORIES
MERCHANDISING

XC RACE JACKET - LADY

CODE: MA079001W
XS - S - M - L - XL

XC RACE JACKET - MAN

CODE: MA079002M
S - M - L - XL - XXL



PRODUCTS

ACCESSORIES
MERCHANDISING

ADHESIVE PAPER TAPE

CODE: MA1014M



PRODUCTS

ACCESSORIES
MERCHANDISING

NOW WOVEN BANNER

CODE: MA1005M
0,80 x 4 mt

PRODUCTS

ACCESSORIES
MERCHANDISING

XC COVER PANTS - UNISEX

CODE: MA079007U
XS - S - M - L - XL - XXL

MAPLUS

MAPLUS

PRODUCTS

ACCESSORIES
MERCHANDISING

STICKER

CODE: MA1001M - 310 x 50 mm
MA1002M - 830 x 140 mm



PRODUCTS

ACCESSORIES
MERCHANDISING

PATCH

CODE: MA1033B - Black
MA1033W - White



PRODUCTS

ACCESSORIES
MERCHANDISING

CAP

CODE: MC0050M



PRODUCTS

ACCESSORIES
MERCHANDISING

XC RACE PANTS - LADY

CODE: MA079003W
XS - S - M - L - XL

XC RACE PANTS - MAN

CODE: MA079004M
S - M - L - XL - XXL

ADHESIVE TAPE

CODE: MA1004M



NO-ADHESIVE PAPER SKI TAPE

CODE: MA1044M



PRODUCTS

ACCESSORIES
MERCHANDISING

HAT

CODE: MC0005M



BAG & ACCESSORIES



PRODUCTS

ACCESSORIES MERCHANDISING

THERMO BELT
CODE: MA0007



PRODUCTS

ACCESSORIES MERCHANDISING

FLAG
CODE: MA1008MS: 55x250 cm
MA1008ML: 65x315 cm

PRODUCTS

ACCESSORIES MERCHANDISING

DRINK FIT BELT
CODE: MB0100



PRODUCTS

ACCESSORIES MERCHANDISING

SKI HARNESS
CODE: MB0105



PRODUCTS

ACCESSORIES MERCHANDISING

XC SKI STRAP
CODE: MA0025M
ALPINE SKI STRAP
CODE: MA0004M



PRODUCTS

ACCESSORIES MERCHANDISING

XC RACING CLIP
CODE: MA0005M



PRODUCTS

ACCESSORIES MERCHANDISING

MA1150 DISPLAY h 195 cm

Standard contents:
MA1303 Shelf 1 pc
MA1305 Hook bar 4 pcs
MA1306 Hook cm 15 15 pcs
MA1307 Hook cm 10 5 pcs
MA1300 Display base 1 pc
MA1301 Display back panel 3 pc
MA1302 Maplus Top Sign 1 pc

MA1160 DISPLAY h 135 cm

Standard contents:
MA1303 Shelf 1 pc
MA1305 Hook bar 3 pcs
MA1306 Hook cm 15 10 pcs
MA1307 Hook cm 10 5 pcs
MA1300 Display base 1 pc
MA1301 Display back panel 2 pc
MA1302 Maplus Top Sign 1 pc

MA1170 DISPLAY h 75 cm

Standard contents:
MA1305 Hook bar 2 pcs
MA1306 Hook cm 15 10 pcs
MA1300 Display base 1 pc
MA1301 Display back panel 1 pc
MA1302 Maplus Top Sign 1 pc

DISPLAY ACCESSORIES:

MA1300 DISPLAY BASE
MA1301 DISPLAY BACK PANEL
MA1302 MAPLUS TOP SIGN
MA1303 SHELF
MA1304 LOCKED GLASSED SHOWCASE
MA1305 HOOK BAR
MA1306 HOOK CM 15
MA1307 HOOK CM 10

PRODUCTS

ACCESSORIES MERCHANDISING

SKI HOLDING STRIPE
CODE: MA0015M
for XC & Alpine ski



STRESS IT SPRAY IT RESTORE IT

Wet...mud.. rain.... if you are a sport and outdoor life addicted, you often meet them on your way.

MAPLUS SUPER CARE LINE ensure that the high techs of your textiles and equipment go on longer and longer with you.

And with the **NEW ECO SUPER CARE LINE** totally environmentally oriented - while you care of your stuff, you focus on the biggest heritage we love and we must take care of.



PRODUCTS

SUPER CARE LINE

CLOTHING SUPER CARE
CODE: MI0001
6 x 250 ml - Display Box

TEXTILE SUPER CARE
CODE: MI0005
6 x 250 ml - Display Box

SHOES & GLOVES SUPER CARE
CODE: MI0010
6 x 250 ml - Display Box

GOLF SHOES & GLOVES SUPER CARE
CODE: MI0015
6 x 250 ml - Display Box

UNIVERSAL SANITIZING
CODE: MI0050 - 250 ml Spray
CODE: MI0051 - 5 Lt - Liquid



PRODUCTS

ECO SUPER CARE LINE

ECO CLOTHING SUPER CARE
CODE: MI0101
SIZE: 500 ml

ECO TEXTILE SUPER CARE
CODE: MI0105
SIZE: 500 ml

ECO SHOES & GLOVES SUPER CARE
CODE: MI0110
SIZE: 500 ml

Maflon s.p.a. is the italian leading company into processing high quality fluorchemical products matching the environmental sustainability.

The R&D department produces constantly new formulations of fluorinated polymers to realize appropriate and durable coating solutions for any kind of surface so to create a highly effective protective barrier against different agents as oils, water, food and beverages.

In order to get these results we respect the most advanced rules in term of sustainable development taking the best care of human being.

Recently we have developed a line of eco-compatible active substances, soluble in water-base, so to obtain more and more environment friendly products maintaining excellent characteristics of hydro and oil repellency.

CLOTHING SUPER CARE

CODE: MI0001
6 x 250 ml - Display Box

Super waterproofing spray polymer for high technology functional clothing.

- Special for all membrane textiles (e.g. GORE-TEX®), natural and synthetic clothing included elastic functional textiles. Extremely versatile.
- It guarantees the best impregnation maintaining the original breathability.
- It creates a highly effective protective barrier guaranteeing the best results in term of oil and hydro repellency and anti-stain properties.
- Easy and quick to use

TEXTILE SUPER CARE

CODE: MI0005
6 x 250 ml - Display Box

Super waterproofing spray polymer for high technology fabric of tents, backpacks, bags, gloves, and umbrellas.

- Special for all natural and synthetic functional textiles and membrane textiles (e.g. GORE-TEX®). Extremely versatile.
- It guarantees the best impregnation maintaining the original breathability.
- It creates a highly effective protective barrier guaranteeing the best results in term of oil and hydro repellency and anti-stain properties.
- Easy and quick to use

SHOES & GLOVES SUPER CARE

CODE: MI0010
6 x 250 ml - Display Box

Super waterproofing spray polymer for high technology outdoor and mountains shoes and gloves in leather or mixed fabrics.

- Special for all membrane textiles (e.g. GORE-TEX®), natural and synthetic functional textiles and leather. Extremely versatile.
- It guarantees the best impregnation maintaining the original breathability.
- It creates a highly effective protective barrier guaranteeing the best results in term of oil and hydro repellency and anti-stain properties.
- It nourishes the outer material conserving the original flexibility.
- Easy and quick to use

GOLF SHOES & GLOVES SUPER CARE

CODE: MI0015
6 x 250 ml - Display Box

Super waterproofing spray polymer for high technology golf shoes and gloves in leather or mixed fabrics.

- Special for all leather and natural and synthetic functional textiles. Extremely versatile.
- It guarantees the best impregnation maintaining the original breathability.
- It creates a highly effective protective barrier guaranteeing the best results in term of oil and hydro repellency and anti-stain properties.
- It nourishes the outer material conserving the original flexibility.
- Easy and quick to use

UNIVERSAL SANITIZING

CODE: MI0050 - 250 ml Spray
CODE: MI0051 - 5 lt - Liquid

Super effective and long-lasting sanitizing for helmets, boots, gloves and shoes.

- Extremely versatile for professional and leisure applications.
- It totally neutralizes unpleasant odors leaving a fresh neutral fragrance.
- Environment friendly it works with total absence of corrosive or irritating action.
- The regular use ensures long-lasting freshness
- Easy and quick to use



ECO CLOTHING SUPER CARE

CODE: MI0001
SIZE: 500 ml

Recently we have developed a line of eco-compatible active substances, soluble in water-base, so to obtain more and more environment friendly products maintaining excellent characteristics of hydro and oil repellency.

Maflon s.p.a. is fully involved in the LCPFCs (Long-chain perfluorinated chemicals) elimination process therefore all our products do not contain PFOA and related compounds.

From this very high level experience the Maplus Care Line was born guaranteeing the best results in term of maintaining the oil and hydro repellency and the anti-stain properties of the functional clothing, technical textiles and all kind of outdoor and mountain shoes conserving the correct and effective breathability.

Waterproofing spray polymer for high technology functional clothing

- Special for all membrane textiles (e.g. GORE-TEX®), natural and synthetic clothing included elastic functional textiles. Extremely versatile.
- It guarantees the best impregnation maintaining the original breathability.
- Special formula soluble in water-base. Environment friendly.
- It creates an effective protective barrier guaranteeing the best results in term of oil and hydro repellency and anti-stain properties.
- Environment friendly trigger spray without propellant gas

ECO TEXTILE SUPER CARE

CODE: MI0105
SIZE: 500 ml

Waterproofing spray polymer for high technology fabric of tents, backpacks, bags, gloves, and umbrellas.

- Special for all natural and synthetic functional textiles and membrane textiles (e.g. GORE-TEX®). Extremely versatile.
- It guarantees the best impregnation maintaining the original breathability.
- Special formula soluble in water-base. Environment friendly.
- It creates a highly effective protective barrier guaranteeing the best results in term of oil and hydro repellency and anti-stain properties.
- Environment friendly trigger spray without propellant gas
- Easy and quick to use

ECO SHOES & GLOVES SUPER CARE

CODE: MI0110
SIZE: 500 ml

Waterproofing spray polymer for high technology outdoor and mountains shoes and gloves in leather or mixed fabrics.

- Special for all membrane textiles (e.g. GORE-TEX®), natural and synthetic functional textiles and leather. Extremely versatile.
- It guarantees the best impregnation maintaining the original breathability.
- Special formula soluble in water-base. Environment friendly.
- It creates a highly effective protective barrier guaranteeing the best results in term of oil and hydro repellency and anti-stain properties.
- It nourishes the outer material conserving the original flexibility.
- Environment friendly trigger spray without propellant gas
- Easy and quick to use



MAPLUS®

MAFLON S.P.A - MAPLUS DIVISION
MAFLON S.p.A. - Viale Bianca Maria, 41 - 20122 Milano (Mi)
PH. +39 035 4494383 - FAX +39 035 4425443
www.maplus.it - e-mail: info@maplus.it

OFFICIAL SUPPLIER



MAPLUS® is a registered trade mark of Maflon S.p.A.

Maflon S.p.A. reserves the right to modify or discontinue any product in every moment at its own discretion or as a result of supervening regulations incompatible with those reported. Every product may not be available in all countries.